

DIN 5482

CODICE DI ORDINAZIONE / ORDERING CODE

200 DAB 2 XX X 0

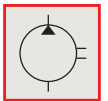
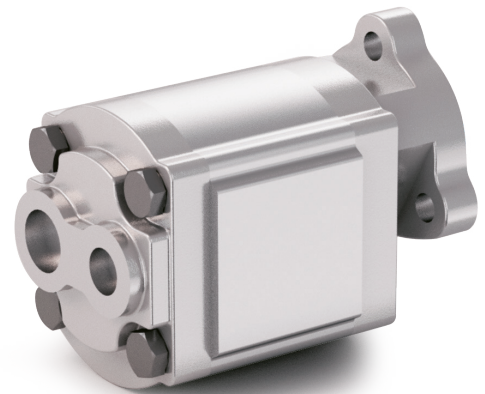
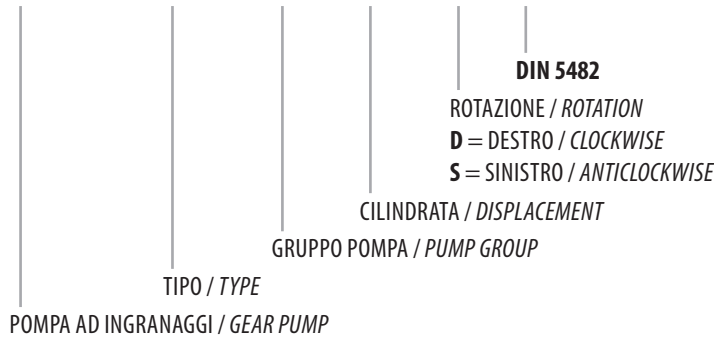

DAB 25

1

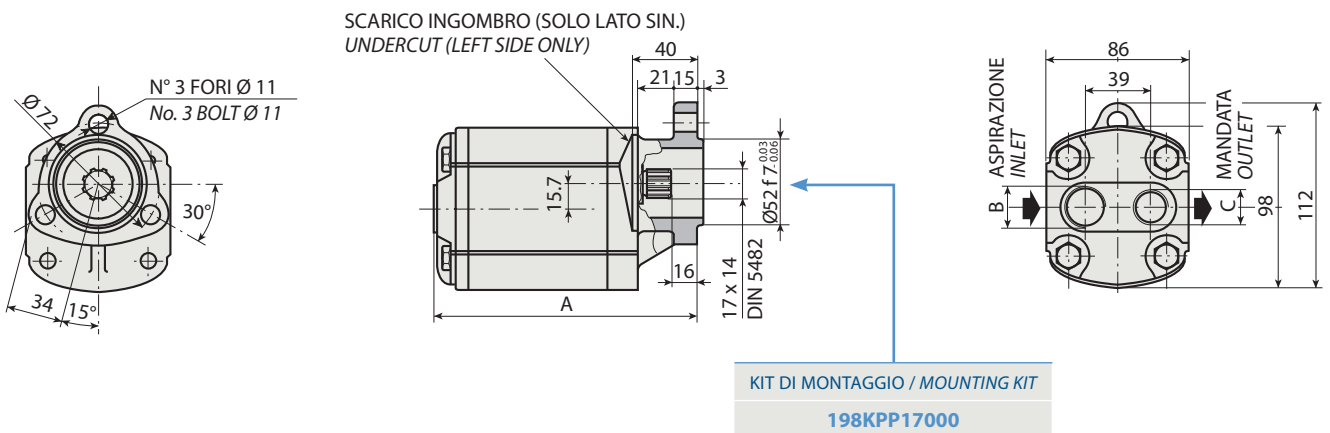

CARATTERISTICHE E DATI TECNICI / SPECIFICATIONS AND TECHNICAL DATA

TIPO TYPE	CODICE / CODE		CILINDRATA DISPLACEMENT	A mm	B ASPIRAZIONE INLET	C MANDATA OUTLET	PESO WEIGHT kg
	ROTAZIONE DESTRA CLOCKWISE ROT.	ROTAZIONE SINISTRA ANTICLOCKWISE ROT.	cm ³ /rev.				
DAB 25	200DAB225D0	200DAB225S0	25	164.5	3/4" G	1/2" G	3.2

KIT RASAMENTI / THRUST PLATES KIT CODICE / CODE 20602300000

KIT GUARNIZIONI COMPLETO / COMPLETE SEALS KIT CODICE / CODE 21902500000

Per la scelta dei raccordi orientabili vedi pag. 212-213 / For the selection of adjustable fittings see page 212-213

- A richiesta possono essere fornite le pompe ad ingranaggi con le guarnizioni HNBR per climi freddi (-40 °C).
- On request our gear pumps may be supplied with HNBR seals for cold climates (-40 °C).

TIPO / TYPE			
Cilindrata <i>Displacement</i>	Vg	cm ³ /n cm ³ /rev.	
Pressione massima continua <i>Max continuous operating pressure</i>	P1		
Pressione massima intermittente <i>Max intermittent operating pressure</i>	(max 30 s) P2	bar	
Pressione massima di picco <i>Max peak pressure</i>	(≤ 0.1 s) P3		
Velocità massima intermittente <i>Max intermittent speed</i>	(P ≤ 20 bar) n3		
Velocità massima continua <i>Max continuous speed</i>	(≤ P1) n1	n/min r.p.m.	
Velocità minima intermittente <i>Min intermittent speed</i>	(≤ P2 x 0.5) (max 30 s) n4		

DAB 25	
	25
	120
	150
	180
	2500
	1500
	650

1

DIAGRAMMI / DIAGRAMS

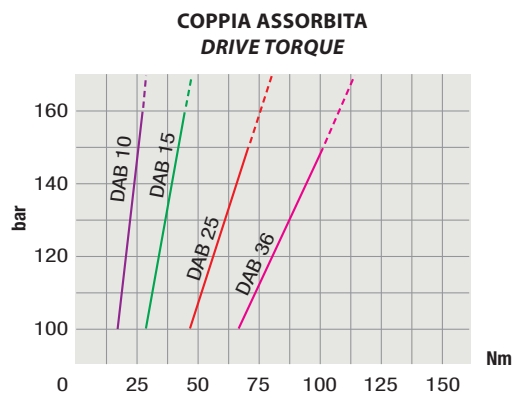
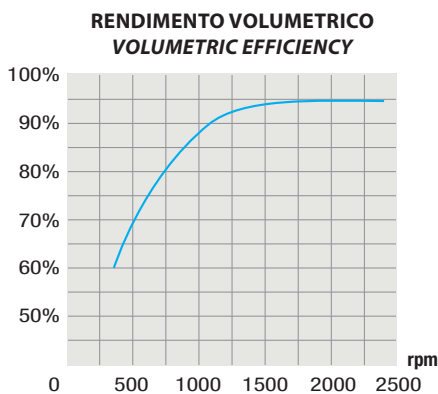
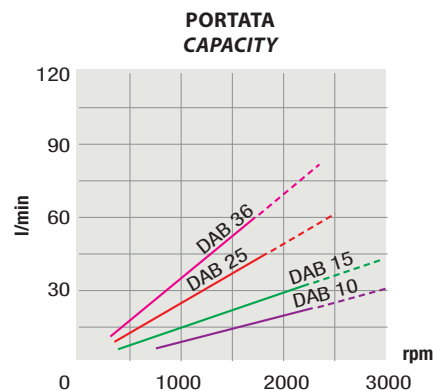
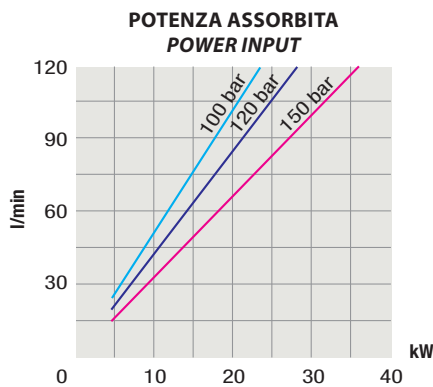

RILIEVI ESEGUITI CON OLIO ISO VG 46 A 50° C ($\nu = 30$ cSt)
THE ABOVE SPECIFICATIONS REFER TO OIL TYPE ISO VG 46 AT 50° C ($\nu = 30$ cSt)