

DIN 5462 SE

CODICE DI ORDINAZIONE / ORDERING CODE

200 FZL XXX X S

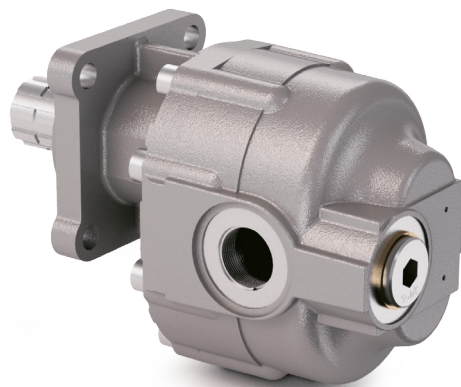
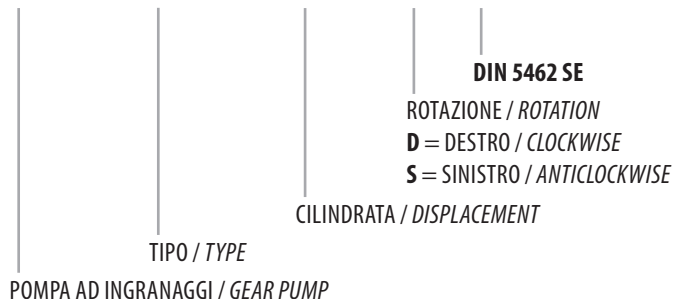

ALBERO USCITA NON SUPPORTATO
OUTPUT SHAFT NOT SUPPORTED



1

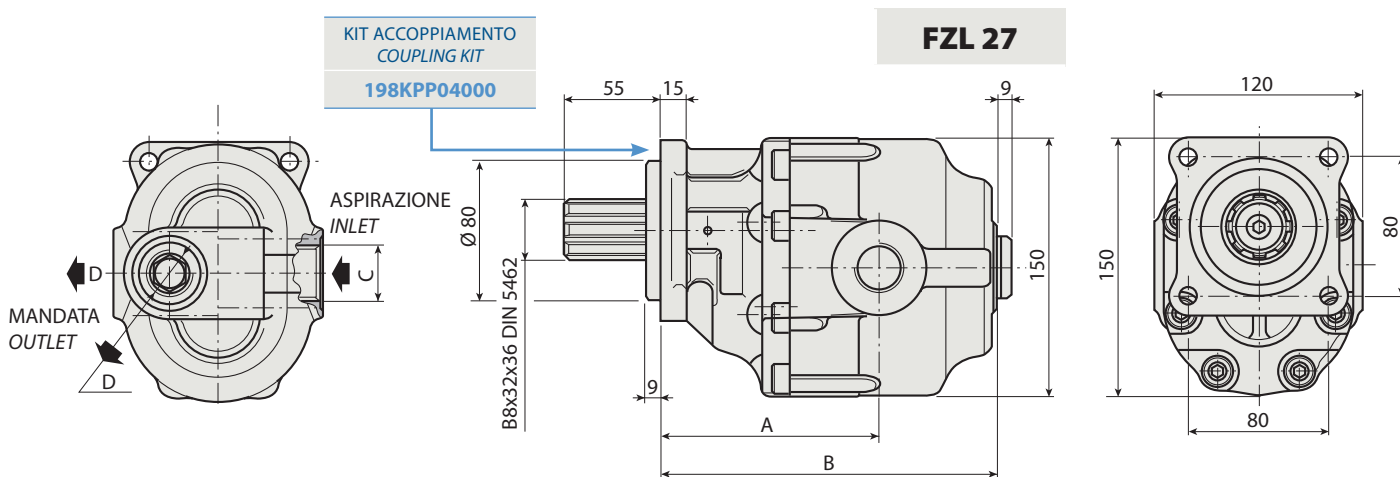

CARATTERISTICHE E DATI TECNICI / SPECIFICATIONS AND TECHNICAL DATA

TIPO TYPE	CODICE / CODE		CILINDRATA DISPLACEMENT cm ³ /rev.	A mm	B mm	C ASPIRAZIONE INLET	D MANDATA OUTLET	PESO WEIGHT kg
	ROTAZIONE DESTRA CLOCKWISE ROT.	ROTAZIONE SINISTRA ANTICLOCKWISE ROT.						
FZL 27	200FZL027DS	200FZL027SS	27	105	152.5	3/4" G	1/2" G	9.3

KIT RASAMENTI / THRUST PLATES KIT CODICE / CODE 20601800000

KIT GUARNIZIONI COMPLETO / COMPLETE SEALS KIT CODICE / CODE 21900800000

Per la scelta dei raccordi orientabili vedi pag. 212-213 / For the selection of adjustable fittings see page 212-213

- A richiesta possono essere fornite le pompe ad ingranaggi con le guarnizioni HNBR per climi freddi (-40 °C).
- On request our gear pumps may be supplied with HNBR seals for cold climates (-40 °C).

DIN 5462 SE

TIPO / TYPE		
Cilindrata <i>Displacement</i>	Vg	cm ³ /n cm ³ /rev.
Pressione massima continua <i>Max continuous operating pressure</i>	P1	bar
Pressione massima intermittente <i>Max intermittent operating pressure</i>	(max 30 s) P2	
Pressione massima di picco <i>Max peak pressure</i>	(≤ 0.1 s) P3	
Velocità massima intermittente <i>Max intermittent speed</i>	(P ≤ 20 bar) n3	n/min r.p.m.
Velocità massima continua <i>Max continuous speed</i>	(≤ P1) n1	
Velocità minima intermittente <i>Min intermittent speed</i>	(≤ P2 x 0.5) (max 30 s) n4	

FZL 27

27
300
325
450
3500
2200
350

1

DIAGRAMMI / DIAGRAMS

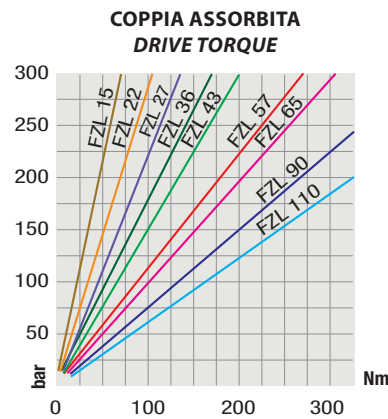
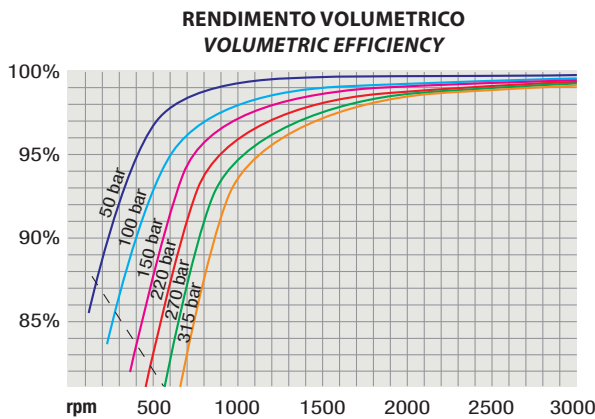
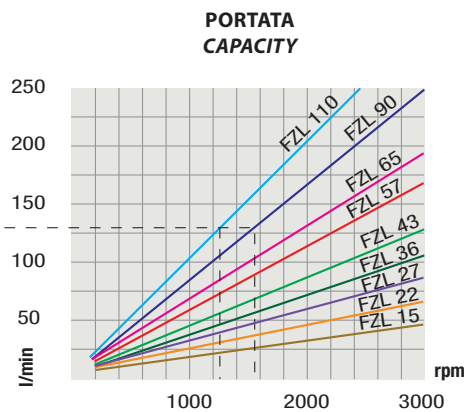
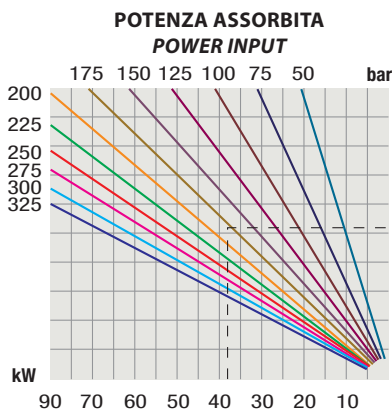

RILIEVI ESEGUITI CON OLIO ISO VG 46 A 50° C ($\nu = 30$ cSt)
THE ABOVE SPECIFICATIONS REFER TO OIL TYPE ISO VG 46 AT 50° C ($\nu = 30$ cSt)