

DIN 5462 SE

CODICE DI ORDINAZIONE / ORDERING CODE

200 FZH XXX X S

TIPO / TYPE
POMPA AD INGRANAGGI / GEAR PUMP

DIN 5462 SE
ROTAZIONE / ROTATION
D = DESTRO / CLOCKWISE
S = SINISTRO / ANTICLOCKWISE
CILINDRATA / DISPLACEMENT

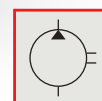
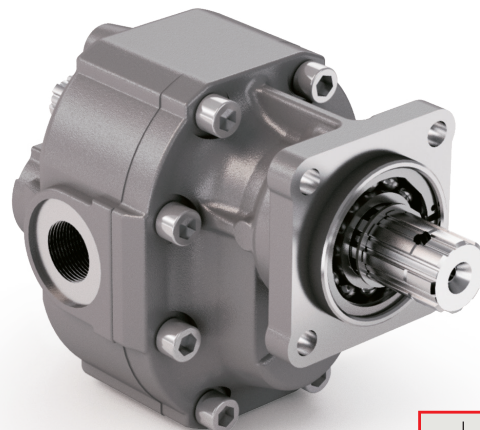

FZH 116

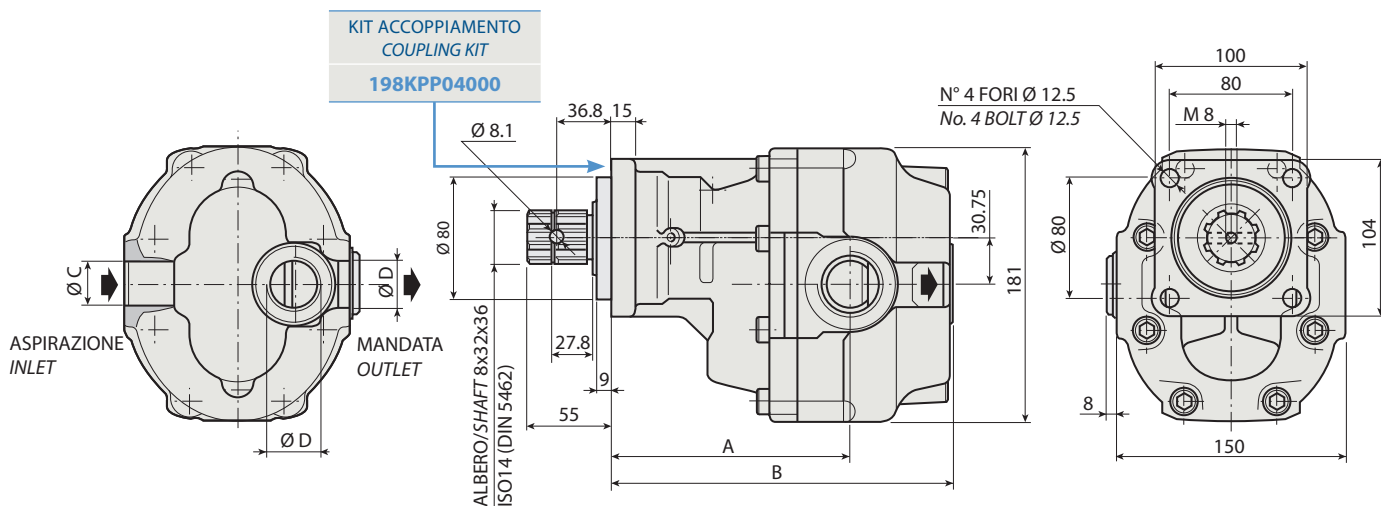

CARATTERISTICHE E DATI TECNICI / SPECIFICATIONS AND TECHNICAL DATA

TIPO TYPE	CODICE / CODE		CILINDRATA DISPLACEMENT	A	B	C	D	PESO WEIGHT
	ROTAZIONE DESTRA CLOCKWISE ROT.	ROTAZIONE SINISTRA ANTICLOCKWISE ROT.	cm ³ /rev.	mm	mm	ASPIRAZIONE INLET	MANDATA OUTLET	kg
FZH 116	200FZH116DS	200FZH116SS	116	139.5	210.5	1" ¼ G	1" G	20.7

KIT RASAMENTI / THRUST PLATES KIT CODICE / CODE 2H451075000

KIT GUARNIZIONI COMPLETO / COMPLETE SEALS KIT CODICE / CODE 21901500000

Per la scelta dei raccordi orientabili vedi pag. 212-213 / For the selection of adjustable fittings see page 212-213

- A richiesta possono essere fornite le pompe ad ingranaggi con le guarnizioni HNBR per climi freddi (-40 °C).
- On request our gear pumps may be supplied with HNBR seals for cold climates (-40 °C).

DIN 5462 SE

TIPO / TYPE		
Cilindrata <i>Displacement</i>	Vg	cm ³ /n cm ³ /rev.
Pressione massima continua <i>Max continuous operating pressure</i>	P1	
Pressione massima intermittente <i>Max intermittent operating pressure</i>	(max 30 s) P2	bar
Pressione massima di picco <i>Max peak pressure</i>	(≤ 0.1 s) P3	
Velocità massima intermittente <i>Max intermittent speed</i>	(P ≤ 20 bar) n3	
Velocità massima continua <i>Max continuous speed</i>	(≤ P1) n1	n/min r.p.m.
Velocità minima intermittente <i>Min intermittent speed</i>	(≤ P2 x 0.5) (max 30 s) n4	

FZH 116
116
250
280
340
3000
1500
250

1

DIAGRAMMI / DIAGRAMS

**POTENZA ASSORBITA
POWER INPUT**

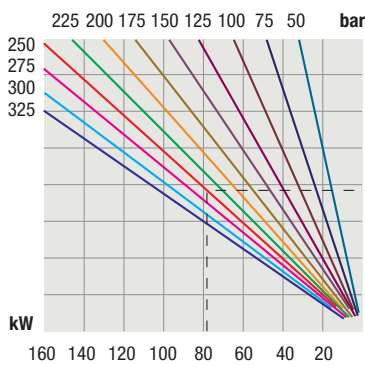

**PORTATA
CAPACITY**

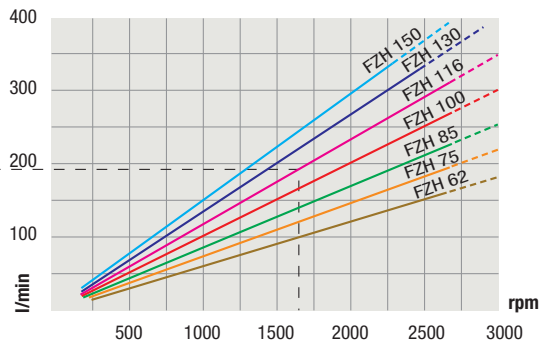

**RENDIMENTO VOLUMETRICO
VOLUMETRIC EFFICIENCY**

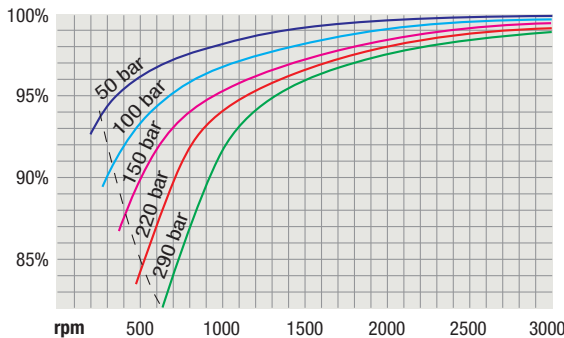

**COPPIA ASSORBITA
DRIVE TORQUE**

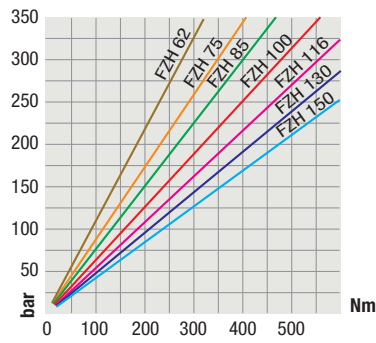

RILIEVI ESEGUITI CON OLIO ISO VG 46 A 50° C ($\nu = 30$ cSt)
THE ABOVE SPECIFICATIONS REFER TO OIL TYPE ISO VG 46 AT 50° C ($\nu = 30$ cSt)