

DIN 5462 SE

CODICE DI ORDINAZIONE / ORDERING CODE

200 FZH XXX X S

TIPO / TYPE
POMPA AD INGRANAGGI / GEAR PUMP

DIN 5462 SE
ROTAZIONE / ROTATION
D = DESTRO / CLOCKWISE
S = SINISTRO / ANTICLOCKWISE
CILINDRATA / DISPLACEMENT

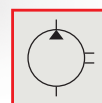
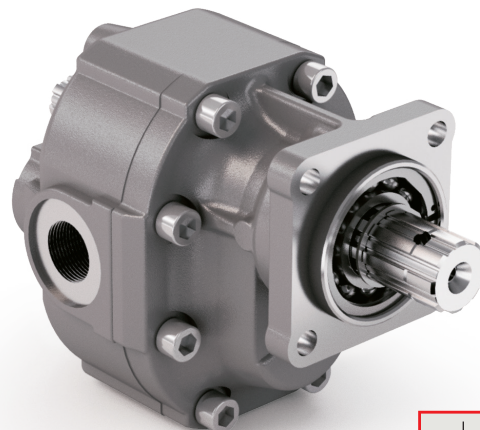

1

FZH 100

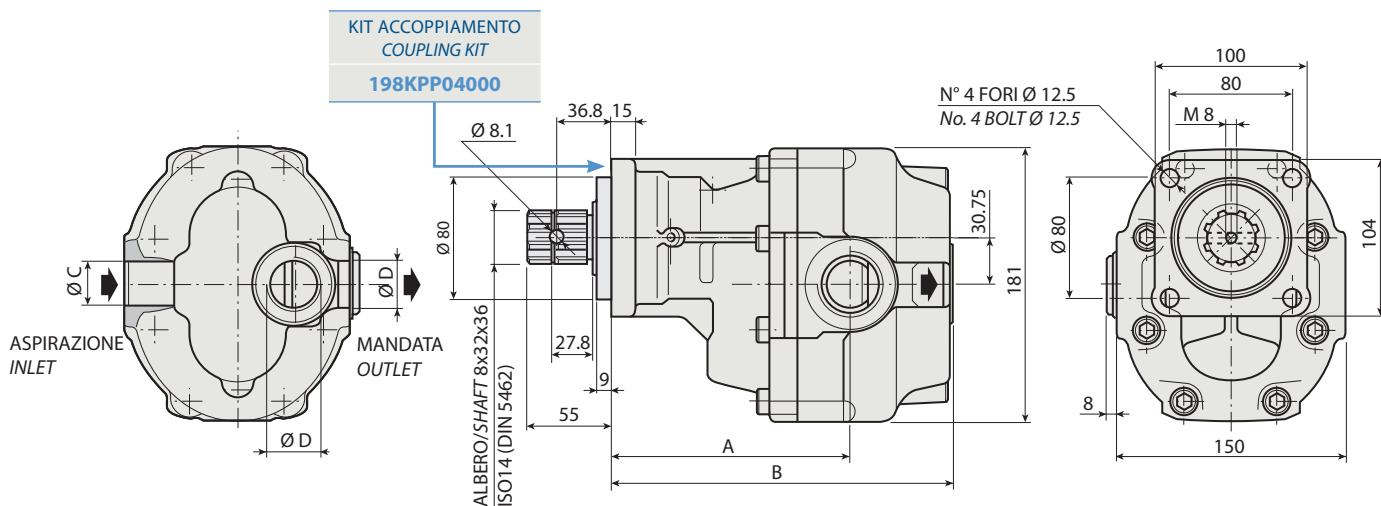

CARATTERISTICHE E DATI TECNICI / SPECIFICATIONS AND TECHNICAL DATA

TIPO TYPE	CODICE / CODE		CILINDRATA DISPLACEMENT	A	B	C	D	PESO WEIGHT
	ROTAZIONE DESTRA CLOCKWISE ROT.	ROTAZIONE SINISTRA ANTICLOCKWISE ROT.	cm ³ /rev.	mm	mm	ASPIRAZIONE INLET	MANDATA OUTLET	kg

FZH 100	200FZH100DS	200FZH100SS	100	139.5	204.5	1"¼ G	1" G	19.8
----------------	--------------------	--------------------	------------	--------------	--------------	--------------	-------------	-------------

KIT RASAMENTI / THRUST PLATES KIT CODICE / CODE 2H451075000

KIT GUARNIZIONI COMPLETO / COMPLETE SEALS KIT CODICE / CODE 21901500000

Per la scelta dei raccordi orientabili vedi pag. 212-213 / For the selection of adjustable fittings see page 212-213

- A richiesta possono essere fornite le pompe ad ingranaggi con le guarnizioni HNBR per climi freddi (-40 °C).
- On request our gear pumps may be supplied with HNBR seals for cold climates (-40 °C).

DIN 5462 SE

TIPO / TYPE			FZH 100
Cilindrata <i>Displacement</i>	Vg	cm ³ /n cm ³ /rev.	100
Pressione massima continua <i>Max continuous operating pressure</i>	P1		260
Pressione massima intermittente <i>Max intermittent operating pressure</i>	(max 30 s) P2	bar	290
Pressione massima di picco <i>Max peak pressure</i>	(≤ 0.1 s) P3		375
Velocità massima intermittente <i>Max intermittent speed</i>	(P ≤ 20 bar) n3		3500
Velocità massima continua <i>Max continuous speed</i>	(≤ P1) n1	n/min r.p.m.	1500
Velocità minima intermittente <i>Min intermittent speed</i>	(≤ P2 x 0.5) (max 30 s) n4		250

1

DIAGRAMMI / DIAGRAMS

POTENZA ASSORBITA
POWER INPUT

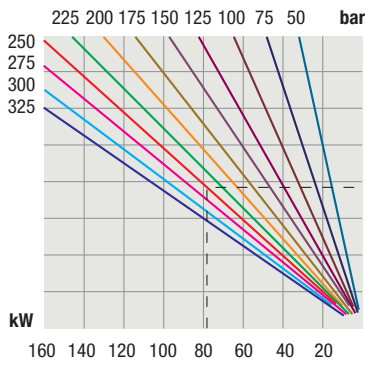

PORTATA
CAPACITY

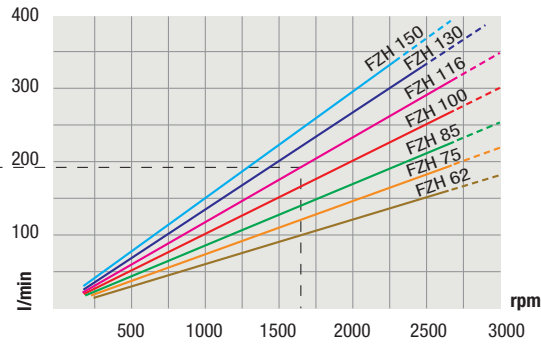

RENDIMENTO VOLUMETRICO
VOLUMETRIC EFFICIENCY

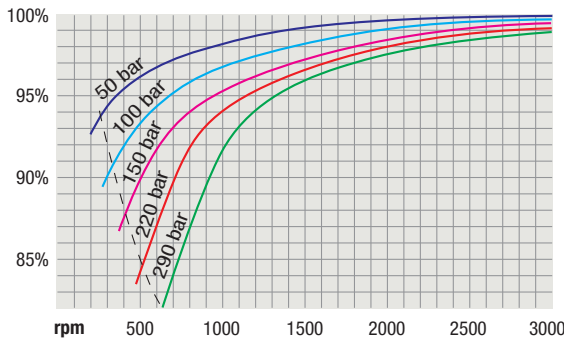

COPPIA ASSORBITA
DRIVE TORQUE

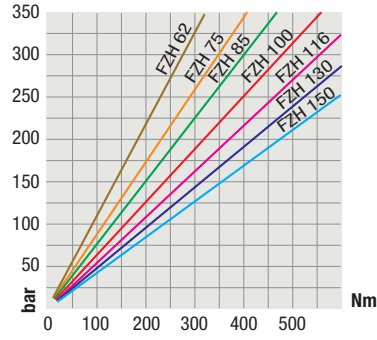

RILIEVI ESEGUITI CON OLIO ISO VG 46 A 50° C ($\nu = 30$ cSt)
THE ABOVE SPECIFICATIONS REFER TO OIL TYPE ISO VG 46 AT 50° C ($\nu = 30$ cSt)