

SERIE ISO

3.1.2.6.

CODICE DI ORDINAZIONE / DECODING

3.1.2.6 . XXX . X . 0 . X . 0

DIN ISO 62
5 4 6 2
SE

ALLESTIMENTI SPECIALI/SPECIAL OPTIONS
0 = NON RICHiesto/STANDARD OPTION
2 = ALBERO SUPPORTATO/BEARING GEAR
4 = ALBERO SUPPORTATO - MANDATA IN TESTA
BEARING GEAR - REAR OUTLET
7 = MANDATA IN TESTA/REAR OUTLET

ROTAZIONE/ROTATION
1 = SINISTRO/ANTICLOCKWISE
2 = DESTRO/CLOCKWISE

CILINDRATA/DISPLACEMENT

CODICE BASE/BASIC CODE

Pompa ad Ingranaggi Gear Pump

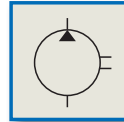
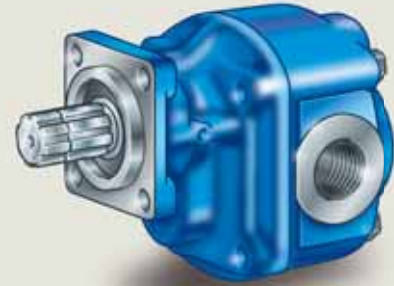

CARATTERISTICHE E DATI TECNICI / SPECIFICATIONS AND TECHNICAL DATA

TIPO TYPE	CODICE CODE	CILINDRATA DISPLACEMENT cm ³ /rev.	A mm	B mm	C ASPIRAZIONE INLET	D MANDATA OUTLET	PESO WEIGHT kg
ISO 62	3.1.2.6.062.X.0.X.0	62	122	186	1" G	3/4" G	20.4

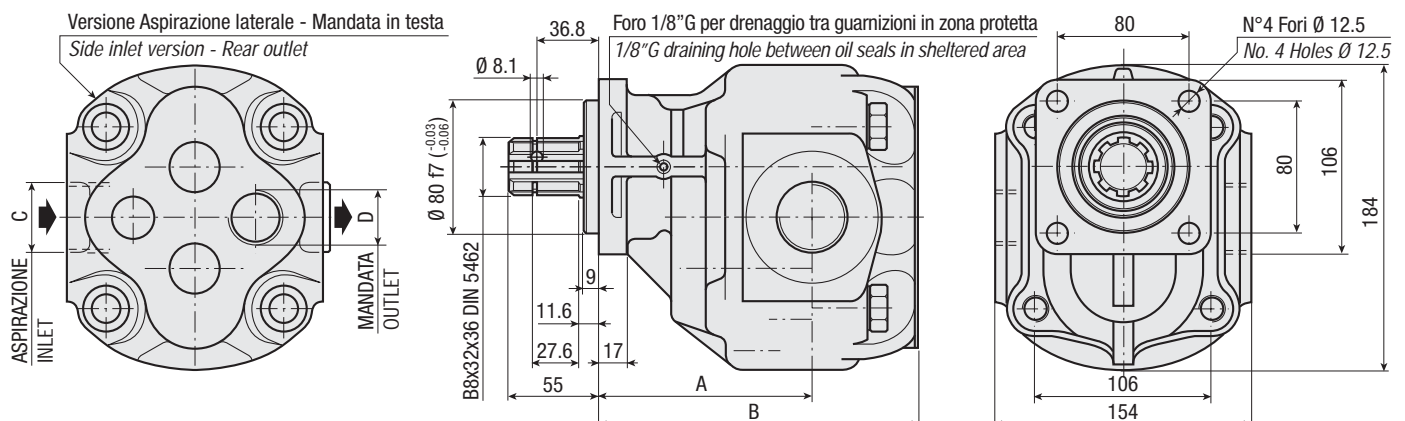

DATI TECNICI / TECHNICAL DATA

ESEMPIO CICLI LAVORO / EXAMPLE OF WORKING CYCLES

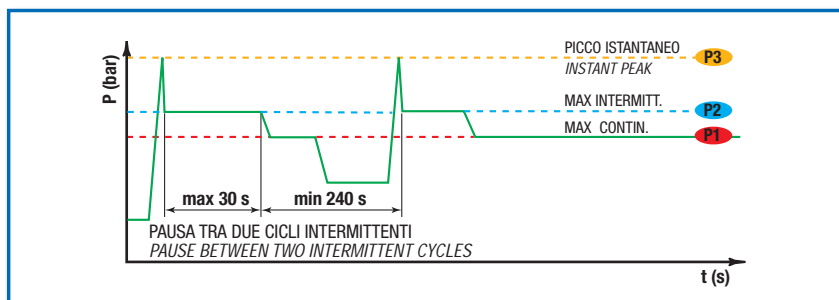

Pressione d'aspirazione: Inlet pressure:	0.7 ÷ 1.5 bar (assoluti/absolute)
Campo viscosità lavoro: Operating viscosity range:	12 ÷ 100 cSt
Temperatura fluido °C (t): Fluid temperature °C (t):	-10° + 80° C

Pressione Lavoro Working Press. P2	Contaminazione / Contamination		Filtro / Filter βx = 75
	NAS 1638	ISO 4406	
≤ 200 bar	12	21/18	40 μm
≥ 200 bar	11	20/17	25 μm

◀ **FILTRAZIONE CONSIGLIATA (ritorno o mandata)**
RECOMMENDED FILTERING (return or outlet)

TIPO / TYPE			ISO 62
Cilindrata Displacement	Vg	cm ³ /n cm ³ /rev.	62
Pressione massima continua Max continuous operating pressure	P1		300
Pressione massima intermittente Max intermitt. operating pressure (max 30 s)	P2	bar	350
Pressione massima di picco Max peak pressure (≤ 0.1 s)	P3		450
Velocità massima intermittente Max intermittent speed (P ≤ 20 bar)	n3		3800
Velocità massima continua Max continuous speed (≤ P1)	n1	n/min r.p.m.	2000
Velocità minima intermittente Min intermittent speed (≤ P2 x 0.5) (max 30 s)	n4		400

POTENZA ASSORBITA / ABSORBED POWER

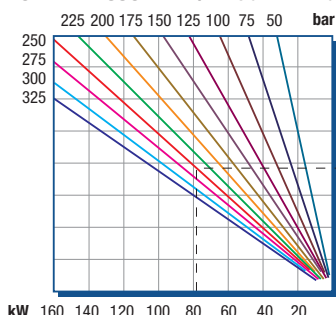

PORTATA / CAPACITY

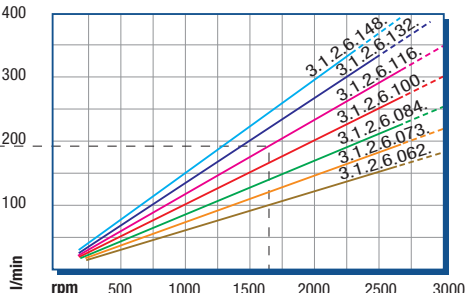

RILIEVI ESEGUITI CON OLIO
ISO VG 46 A 50° C (ν=30 cSt)
THE ABOVE SPECIFICATIONS
REFER TO OIL TYPE ISO
VG 46 AT 50° C (ν=30 cSt)

DIAGRAMMI / DIAGRAMS

RENDIMENTO VOLUMETRICO / VOLUMETRIC EFFICIENCY

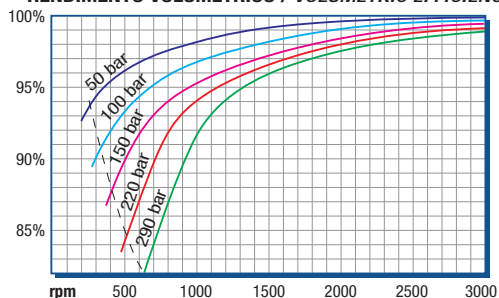

COPPIA ASSORBITA / INPUT TORQUE

