

TANDEM 21 UNI 222

CODICE DI ORDINAZIONE / ORDERING CODE

200 FZO XXX X T

21 UNI 222
 ROTAZIONE / ROTATION
D = DESTRO / CLOCKWISE
S = SINISTRO / ANTICLOCKWISE
 CILINDRATA / DISPLACEMENT
 TIPO / TYPE
 POMPA AD INGRANAGGI / GEAR PUMP

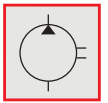
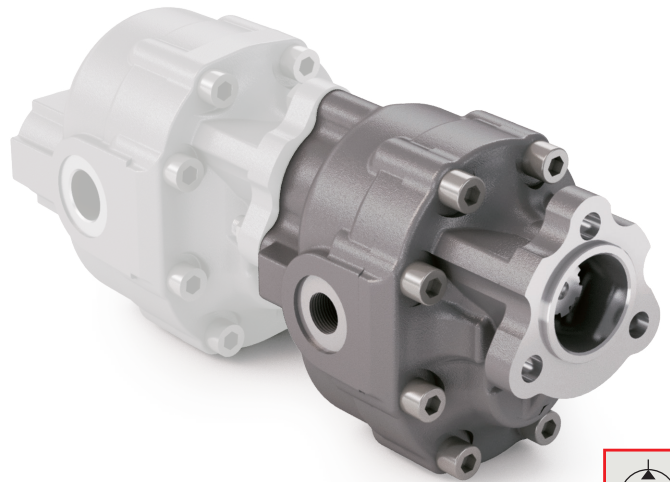

FZO 90 T

1

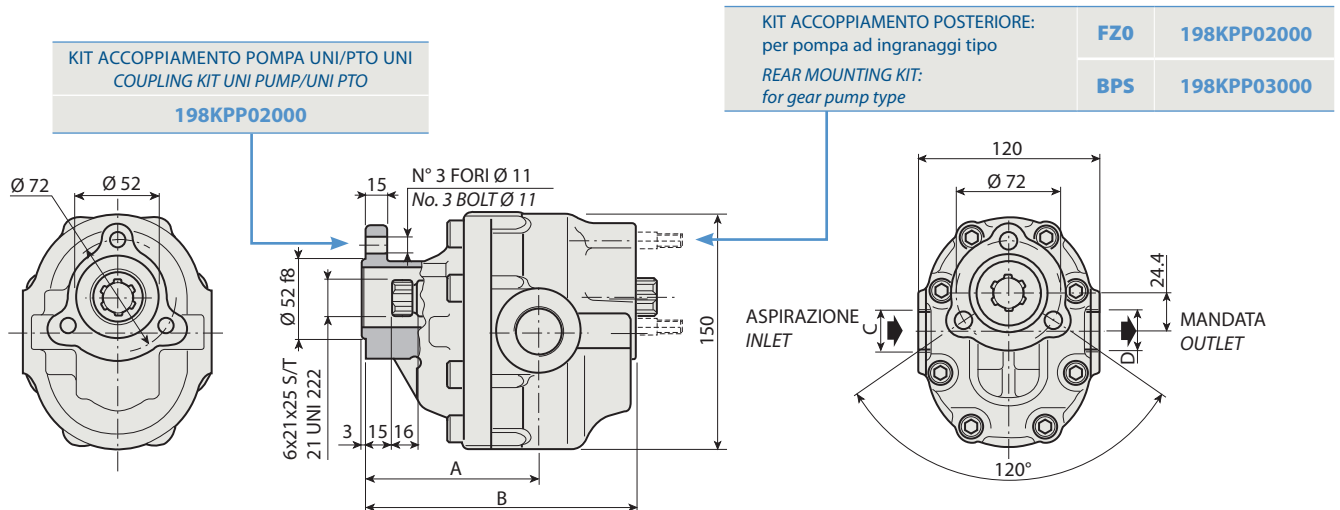

CARATTERISTICHE E DATI TECNICI / SPECIFICATIONS AND TECHNICAL DATA

TIPO TYPE	CODICE / CODE		CILINDRATA DISPLACEMENT cm ³ /rev.	A mm	B mm	C ASPIRAZIONE INLET	D MANDATA OUTLET	PESO WEIGHT kg
	ROTAZIONE DESTRA CLOCKWISE ROT.	ROTAZIONE SINISTRA ANTICLOCKWISE ROT.						

FZO 90 T	200FZ0090DT	200FZ0090ST	84	126	195	1" ¼ G	1" G	12.8
-----------------	--------------------	--------------------	-----------	------------	------------	---------------	-------------	-------------

KIT RASAMENTI / THRUST PLATES KIT CODICE / CODE 20601800000

KIT GUARNIZIONI COMPLETO / COMPLETE SEALS KIT CODICE / CODE 21902300000

Per la scelta dei raccordi orientabili vedi pag. 212-213 / For the selection of adjustable fittings see page 212-213

- A richiesta possono essere fornite le pompe ad ingranaggi con le guarnizioni HNBR per climi freddi (-40 °C).
- On request our gear pumps may be supplied with HNBR seals for cold climates (-40 °C).

TANDEM 21 UNI 222

TIPO / TYPE			
Cilindrata <i>Displacement</i>	Vg	cm ³ /n cm ³ /rev.	
Pressione massima continua <i>Max continuous operating pressure</i>	P1		
Pressione massima intermittente <i>Max intermittent operating pressure</i>	(max 30 s) P2	bar	
Pressione massima di picco <i>Max peak pressure</i>	(≤ 0.1 s) P3		
Velocità massima intermittente <i>Max intermittent speed</i>	(P ≤ 20 bar) n3		
Velocità massima continua <i>Max continuous speed</i>	(≤ P1) n1	n/min r.p.m.	
Velocità minima intermittente <i>Min intermittent speed</i>	(≤ P2 x 0.5) (max 30 s) n4		

FZO 90 T
84
210
230
300
3500
1500
300

DIAGRAMMI / DIAGRAMS

POTENZA ASSORBITA
POWER INPUT

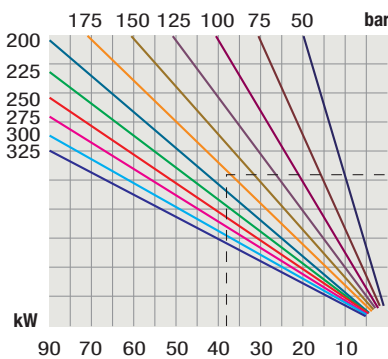

PORTATA
CAPACITY

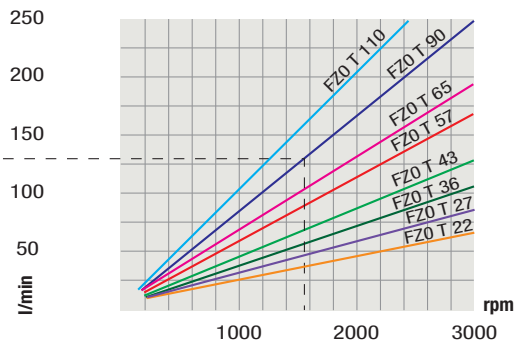

RILIEVI ESEGUITI CON OLIO ISO VG 46
A 50° C ($\nu = 30$ cSt)
THE ABOVE SPECIFICATIONS REFER TO OIL
TYPE ISO VG 46 AT 50° C ($\nu = 30$ cSt)

RENDIMENTO VOLUMETRICO
VOLUMETRIC EFFICIENCY

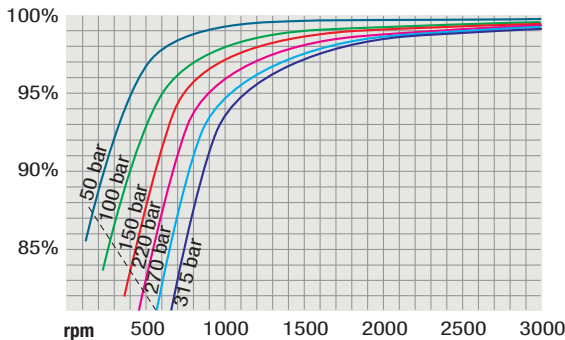

COPPIA ASSORBITA
DRIVE TORQUE

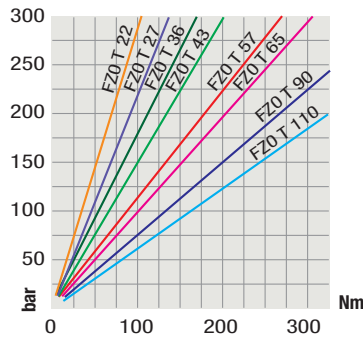

Verificare, nel caso vi sia l'utilizzo
contemporaneo delle due pompe, che la
coppia sull'albero in uscita non superi
i 270 Nm.

*In case of simultaneous use of both pumps,
make sure that the torque on output shaft
does not exceed 270 Nm.*