

# SERIE XP-4D 3.1.7.1.

CODICE DI ORDINAZIONE / DECODING

3.1.7.1 . XXX . X . 0 . X . 0

**DIN**  
5 4 6 2  
**SE**

ALLESTIMENTI SPECIALI/SPECIAL OPTIONS  
0 = NON RICHIESTO/STANDARD OPTION  
7 = ASPIRAZIONE LATERALE - MANDATA IN TESTA  
SIDE INLET - REAR OUTLET

XP-4D 65

ROTAZIONE/ROTATION  
1 = SINISTRO/ANTICLOCKWISE  
2 = DESTRO/CLOCKWISE

CILINDRATA/DISPLACEMENT

CODICE BASE/BASIC CODE

Pompa ad Ingranaggi  
Gear Pump

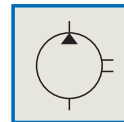
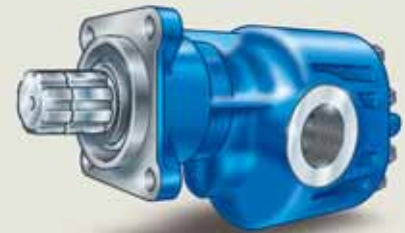

## CARATTERISTICHE E DATI TECNICI / SPECIFICATIONS AND TECHNICAL DATA

TIPO TYPE	CODICE CODE	CILINDRATA DISPLACEMENT cm <sup>3</sup> /rev.	A mm	B mm	C ASPIRAZIONE INLET	D MANDATA OUTLET	PESO WEIGHT kg
--------------	----------------	---	---------	---------	---------------------------	------------------------	----------------------

XP-4D 65	3.1.7.1.065.X.0.X.0	65	117	202	1" G	1" G	12.8
----------	---------------------	----	-----	-----	------	------	------

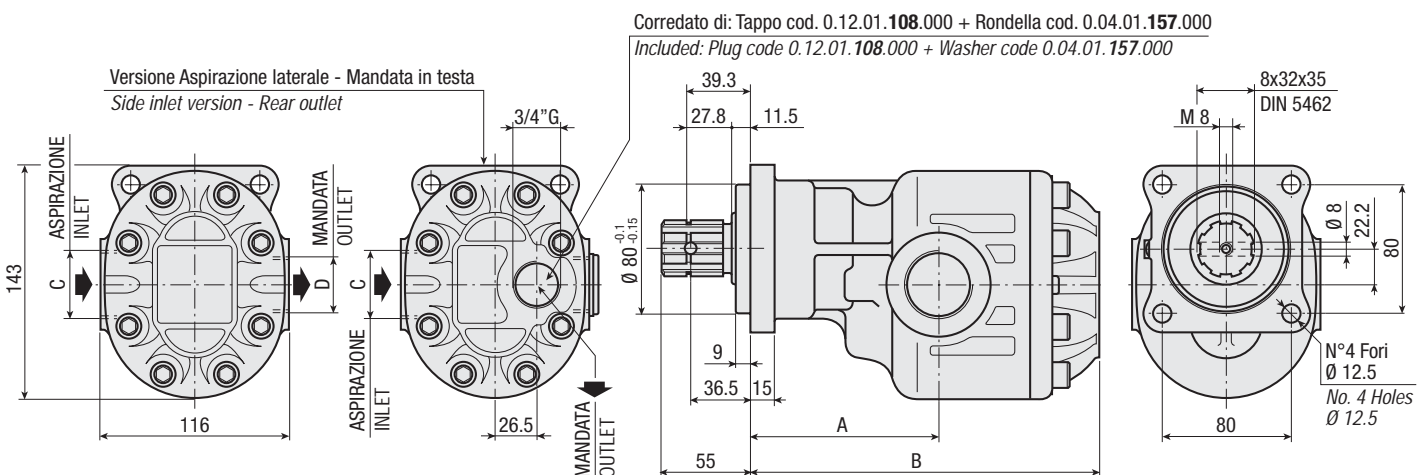

**DATI TECNICI / TECHNICAL DATA**

**ESEMPIO CICLI LAVORO / EXAMPLE OF WORKING CYCLES**

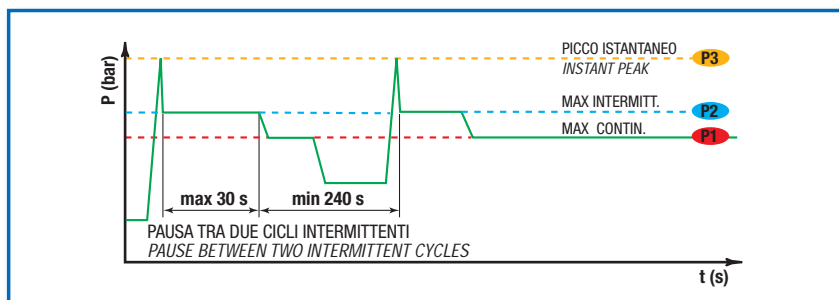

Pressione d'aspirazione: Inlet pressure:	0.7 ÷ 1.5 bar (assoluti/absolute)
Campo viscosità lavoro: Operating viscosity range:	12 ÷ 100 cSt
Temperatura fluido °C (t): Fluid temperature °C (t):	-10° + 80° C

Pressione Lavoro Working Press. P2	Contaminazione / Contamination		Filtro / Filter βx = 75
	NAS 1638	ISO 4406	
≤ 200 bar	12	21/18	40 μm
≥ 200 bar	11	20/17	25 μm

◀ **FILTRAZIONE CONSIGLIATA (ritorno o mandata)**  
**RECOMMENDED FILTERING (return or outlet)**

TIPO / TYPE				XP-4D 65		
Cilindrata Displacement	Vg	cm <sup>3</sup> /n cm <sup>3</sup> /rev.		65		
Pressione massima continua Max continuous operating pressure	P1	bar		220		
Pressione massima intermittente Max intermitt. operating pressure (max 30 s)	P2		265			
Pressione massima di picco Max peak pressure (≤ 0.1 s)	P3		330			
Velocità massima intermittente Max intermittent speed (P ≤ 20 bar)	n3	n/min r.p.m.		3000		
Velocità massima continua Max continuous speed (≤ P1)	n1		2500			
Velocità minima intermittente Min intermittent speed (≤ P2 x 0.5) (max 30 s)	n4		400			

**POTENZA ASSORBITA / ABSORBED POWER**

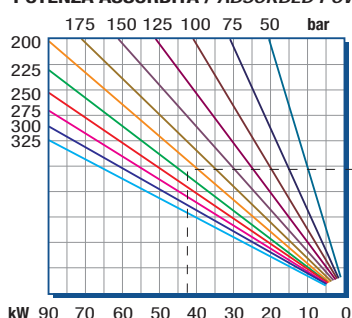

**PORTATA / CAPACITY**

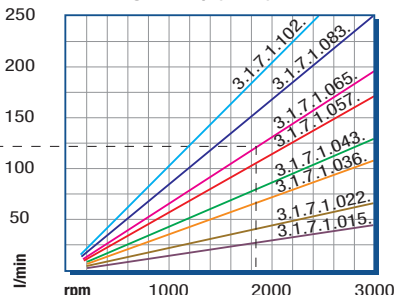

RILIEVI ESEGUITI CON OLIO  
ISO VG 46 A 50° C (ν=30 cSt)  
THE ABOVE SPECIFICATIONS  
REFER TO OIL TYPE ISO  
VG 46 AT 50° C (ν=30 cSt)

**DIAGRAMMI / DIAGRAMS**

**RENDIMENTO VOLUMETRICO - VOLUMETRIC EFFICIENCY**

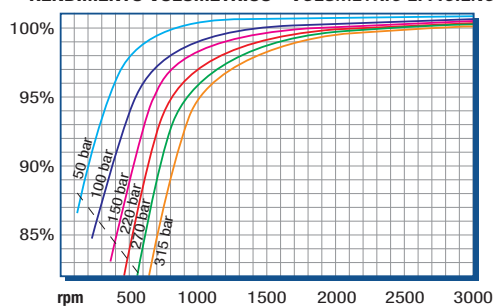

**COPIA ASSORBITA / INPUT TORQUE**

