

TANDEM DIN 5462 SE

CODICE DI ORDINAZIONE / ORDERING CODE

200 FZO XXX X V

DIN 5462 SE
 ROTAZIONE / ROTATION
D = DESTRO / CLOCKWISE
S = SINISTRO / ANTICLOCKWISE
 CILINDRATA / DISPLACEMENT
 TIPO / TYPE
 POMPA AD INGRANAGGI / GEAR PUMP

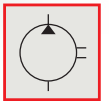
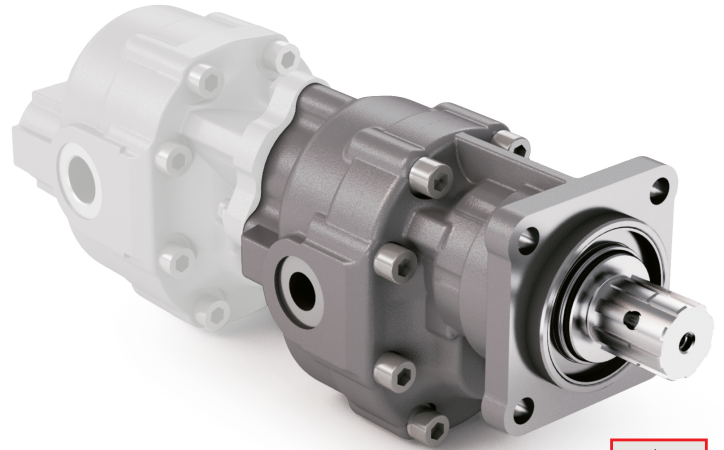

FZO 36 V

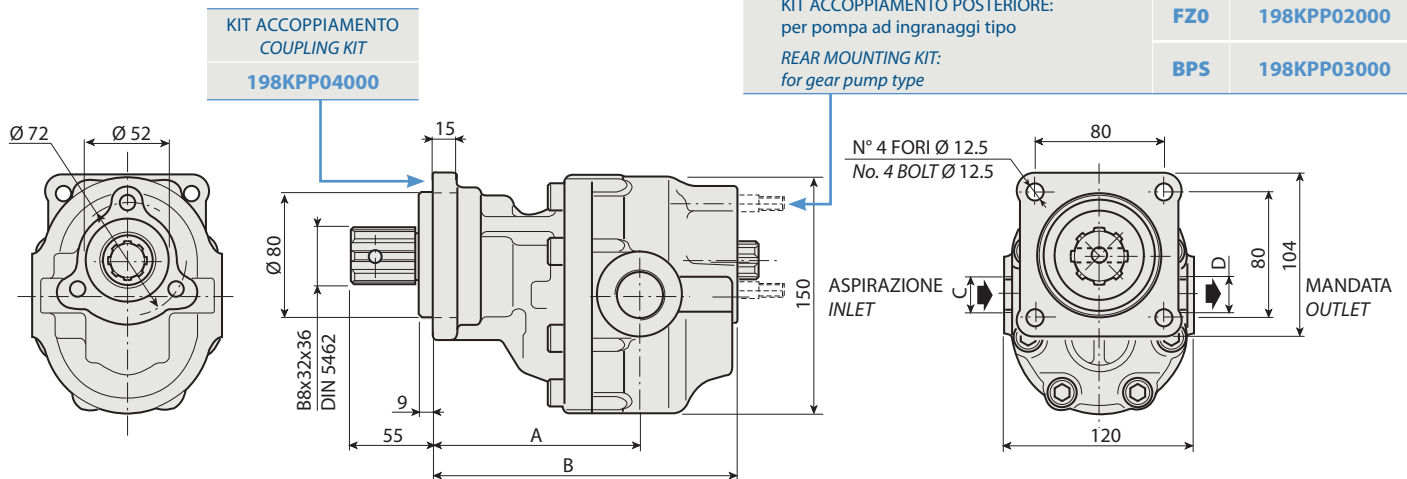

CARATTERISTICHE E DATI TECNICI / SPECIFICATIONS AND TECHNICAL DATA

TIPO TYPE	CODICE / CODE		CILINDRATA DISPLACEMENT cm ³ /rev.	A mm	B mm	C ASPIRAZIONE INLET	D MANDATA OUTLET	PESO WEIGHT kg
	ROTAZIONE DESTRA CLOCKWISE ROT.	ROTAZIONE SINISTRA ANTICLOCKWISE ROT.						
FZO 36 V	200FZ0036DV	200FZ0036SV	36	126	186.5	3/4" G	1/2" G	12.2

KIT RASAMENTI / THRUST PLATES KIT CODICE / CODE 20601800000

KIT GUARNIZIONI COMPLETO / COMPLETE SEALS KIT CODICE / CODE 21902200000

Per la scelta dei raccordi orientabili vedi pag. 212-213 / For the selection of adjustable fittings see page 212-213

- A richiesta possono essere fornite le pompe ad ingranaggi con le guarnizioni HNBR per climi freddi (-40 °C).
- On request our gear pumps may be supplied with HNBR seals for cold climates (-40 °C).

TANDEM DIN 5462 SE

TIPO / TYPE			FZO 36 V
Cilindrata Displacement	Vg	cm ³ /n cm ³ /rev.	36
Pressione massima continua Max continuous operating pressure	P1	bar	300
Pressione massima intermittente Max intermittent operating pressure (max 30 s)	P2		325
Pressione massima di picco Max peak pressure (≤ 0.1 s)	P3		450
Velocità massima intermittente Max intermittent speed (P ≤ 20 bar)	n3	n/min r.p.m.	3500
Velocità massima continua Max continuous speed (≤ P1)	n1		2200
Velocità minima intermittente Min intermittent speed (≤ P2 x 0.5) (max 30 s)	n4		350

DIAGRAMMI / DIAGRAMS

POTENZA ASSORBITA
POWER INPUT

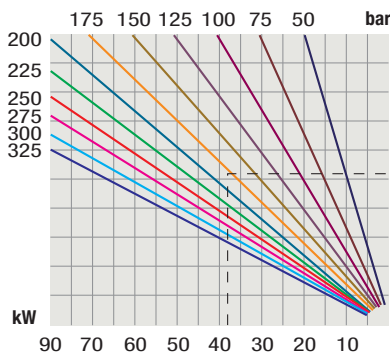

PORTATA
CAPACITY

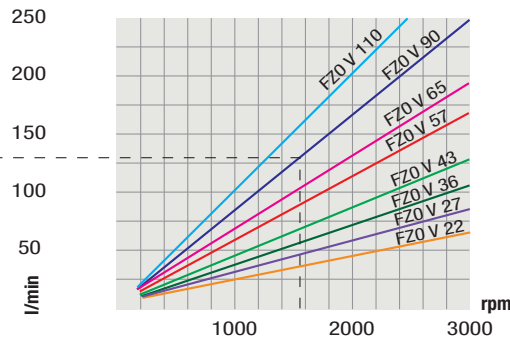

RILIEVI ESEGUITI CON OLIO ISO VG 46
A 50° C ($\nu = 30$ cSt)
THE ABOVE SPECIFICATIONS REFER TO OIL
TYPE ISO VG 46 AT 50° C ($\nu = 30$ cSt)

RENDIMENTO VOLUMETRICO
VOLUMETRIC EFFICIENCY

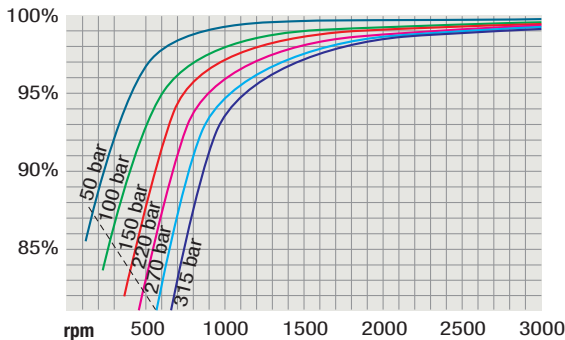

COPPIA ASSORBITA
DRIVE TORQUE

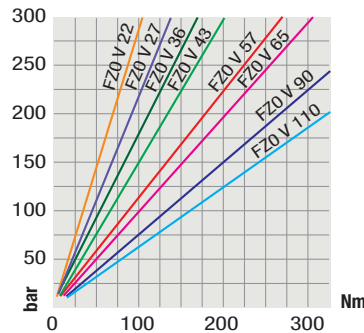

Verificare, nel caso vi sia l'utilizzo contemporaneo delle due pompe, che la coppia sull'albero in uscita non superi i 270 Nm.
In case of simultaneous use of both pumps, make sure that the torque on output shaft does not exceed 270 Nm.