

SERIE XPA-H 3.1.2.5.

CODICE DI ORDINAZIONE / DECODING

3.1.2.5 . XXX . X . 0 . 0 . 0

DIN

5 4 8 2 XPA-H 25

ALLESTIMENTI SPECIALI/SPECIAL OPTIONS
0 = SENZA VALVOLA ELETTRICA/WITHOUT ELECTRIC VALVE

ROTAZIONE/ROTATION
1 = SINISTRO/ANTICLOCKWISE
2 = DESTRO/CLOCKWISE

CILINDRATA/DISPLACEMENT

CODICE BASE/BASIC CODE

Pompa ad Ingranaggi Gear Pump

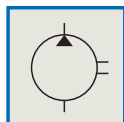
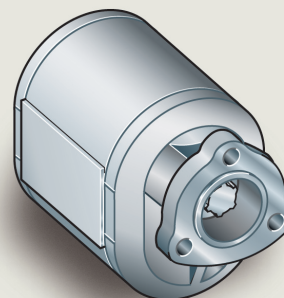

CARATTERISTICHE E DATI TECNICI / SPECIFICATIONS AND TECHNICAL DATA

TIPO TYPE	CODICE CODE	CILINDRATA DISPLACEMENT cm ³ /rev.	A mm	B ASPIRAZIONE INLET	C MANDATA OUTLET	PESO WEIGHT kg
--------------	----------------	---	---------	---------------------------	------------------------	----------------------

XPA-H 25	3.1.2.5.025.X.0.0.0	25	164.5	3/4" G	1/2" G	3.2
----------	---------------------	----	-------	--------	--------	-----

KIT DI MONTAGGIO MOUNTING KIT

2.05.P486.0000

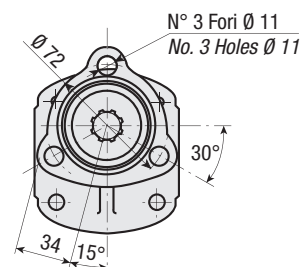
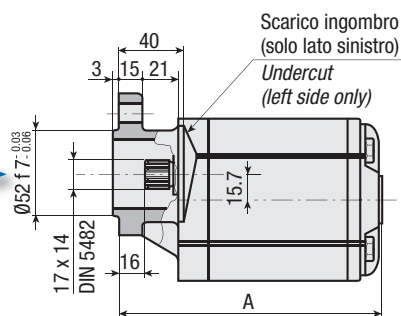
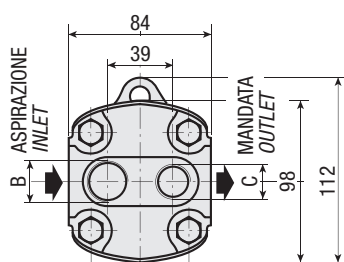

DATI TECNICI / TECHNICAL DATA

ESEMPIO CICLI LAVORO / EXAMPLE OF WORKING CYCLES

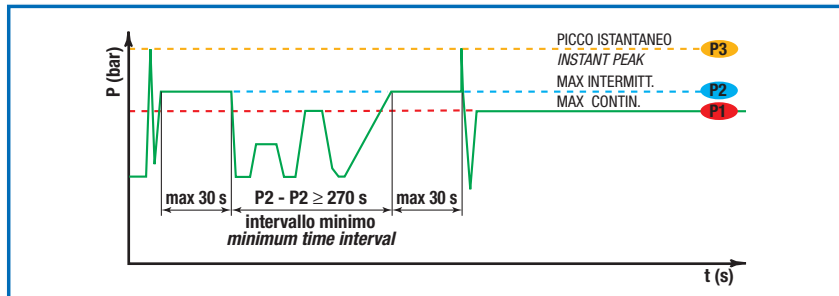

Pressione d'aspirazione: <i>Inlet pressure:</i>	0.7 ÷ 1.5 bar (assoluti/absolute)
Campo viscosità lavoro: <i>Operating viscosity range:</i>	12 ÷ 100 cSt
Temperatura fluido °C (t): <i>Fluid temperature °C (t):</i>	-10° + 80° C

Pressione Lavoro <i>Working Press.</i>	P2	Contaminazione / <i>Contamination</i>		Filtro / <i>Filter</i> βx = 75
		NAS 1638	ISO 4406	
≤ 200 bar		12	21/18	40 μm

◀ **FILTRAZIONE CONSIGLIATA** (ritorno o mandata)
RECOMMENDED FILTERING (return or outlet)

TIPO / <i>TYPE</i>					XPA-H 25
	Cilindrata <i>Displacement</i>	Vg	cm ³ /n cm ³ /rev.		
Pressione massima continua <i>Max continuous operating pressure</i>		P1	bar		120
Pressione massima intermittente <i>Max intermitt. operating pressure</i>	(max 30 s)	P2			150
Pressione massima di picco <i>Max peak pressure</i>	(≤ 0.1 s)	P3			180
Velocità massima intermittente <i>Max intermittent speed</i>	(P ≤ 20 bar)	n3	n/min r.p.m.		2500
Velocità massima continua <i>Max continuous speed</i>	(≤ P1)	n1			1500
Velocità minima intermittente <i>Min intermittent speed</i>	(≤ P2 x 0.5) (max 30 s)	n4			650

POTENZA ASSORBITA / *ABSORBED POWER*

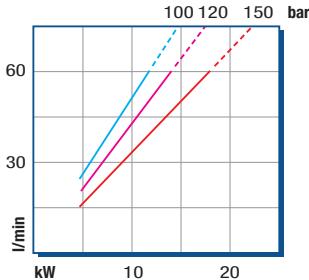

PORTATA / *CAPACITY*

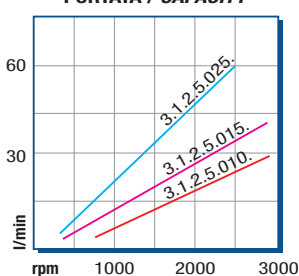

RILIEVI ESEGUITI CON OLIO
ISO VG 46 A 50° C (√=30 cSt)
THE ABOVE SPECIFICATIONS
REFER TO OIL TYPE ISO
VG 46 AT 50° C (√=30 cSt)

DIAGRAMMI / *DIAGRAMS*

RENDIMENTO VOLUMETRICO / *VOLUMETRIC EFFICIENCY*

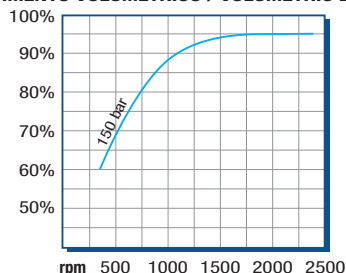

COPPIA ASSORBITA / *INPUT TORQUE*

