

SERIE ISO TANDEM 3.1.2.6.

CODICE DI ORDINAZIONE / DECODING

3.1.2.6 . XXX . X . 0 . X . 0

DIN
5 4 6 2
SE

ALLESTIMENTI SPECIALI / SPECIAL OPTIONS

1 = MONTAGGIO IN TANDEM / TANDEM FITTING

8 = MONTAGGIO IN TANDEM E ALBERO SUPPORTATO
TANDEM FITTING AND BEARING GEAR

ROTAZIONE / ROTATION

1 = SINISTRO / ANTICLOCKWISE

2 = DESTRO / CLOCKWISE

CILINDRATA / DISPLACEMENT

CODICE BASE / BASIC CODE

ISO 148

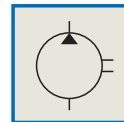

Pompa ad Ingranaggi
Gear Pump

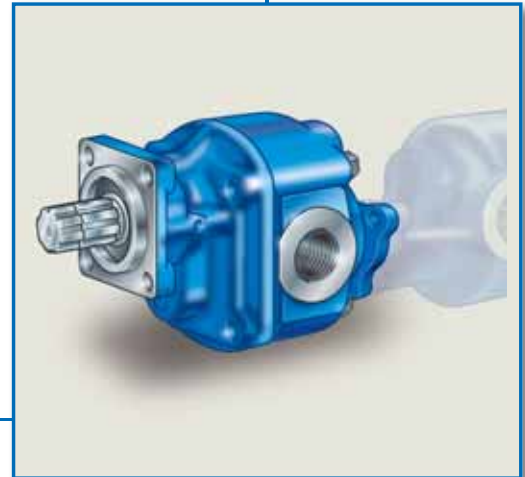

CARATTERISTICHE E DATI TECNICI / SPECIFICATIONS AND TECHNICAL DATA

TIPO TYPE	CODICE CODE	CILINDRATA DISPLACEMENT cm ³ /rev.	A mm	B mm	C ASPIRAZIONE INLET	D MANDATA OUTLET	PESO WEIGHT kg
--------------	----------------	---	---------	---------	---------------------------	------------------------	----------------------

ISO 148	3.1.2.6.148.X.0.X.0	148	143.5	218	1" 1/2 G	1" G	26.2
---------	---------------------	-----	-------	-----	----------	------	------

MANICOTTO PER ACCOPPIAMENTO UNI 21-222
COUPLING SLEEVE UNI 21-222

1.17.01.001.000

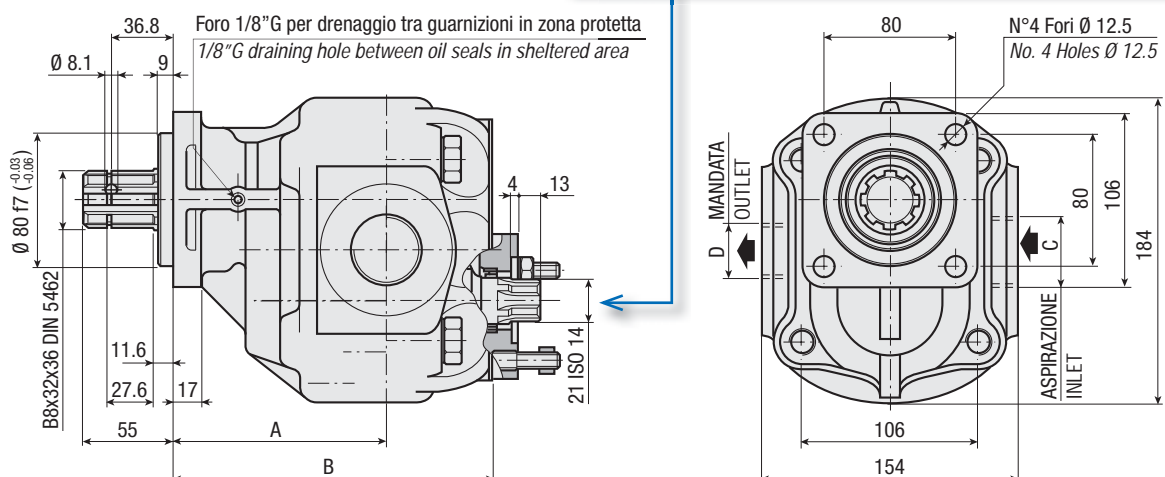

DATI TECNICI / TECHNICAL DATA

ESEMPIO CICLI LAVORO / EXAMPLE OF WORKING CYCLES

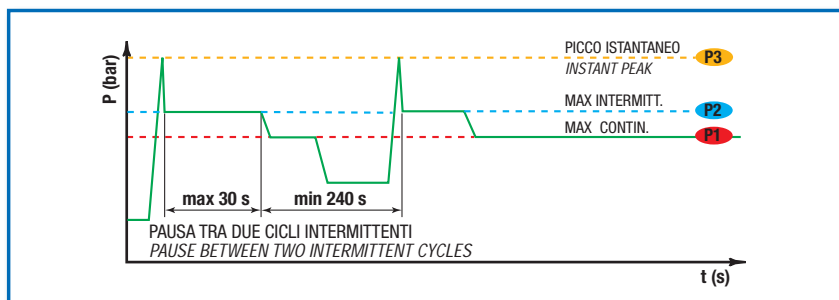

Pressione d'aspirazione: Inlet pressure:	0.7 ÷ 1.5 bar (assoluti/absolute)
Campo viscosità lavoro: Operating viscosity range:	12 ÷ 100 cSt
Temperatura fluido °C (t): Fluid temperature °C (t):	-10° + 80° C

Pressione Lavoro Working Press. P2	Contaminazione / Contamination		Filtro / Filter βx = 75
	NAS 1638	ISO 4406	
≤ 200 bar	12	21/18	40 μm
≥ 200 bar	11	20/17	25 μm

◀ **FILTRAZIONE CONSIGLIATA (ritorno o mandata)**
RECOMMENDED FILTERING (return or outlet)

TIPO / TYPE								ISO 148
	Vg	cm ³ /n	cm ³ /rev.					
Cilindrata Displacement	Vg	cm ³ /n	cm ³ /rev.					148
Pressione massima continua Max continuous operating pressure	P1							190
Pressione massima intermittente Max intermitt. operating pressure (max 30 s)	P2	bar						230
Pressione massima di picco Max peak pressure (≤ 0.1 s)	P3							270
Velocità massima intermittente Max intermittent speed (P ≤ 20 bar)	n3							3000
Velocità massima continua Max continuous speed (≤ P1)	n1	n/min	r.p.m.					1500
Velocità minima intermittente Min intermittent speed (≤ P2 x 0.5) (max 30 s)	n4							250

POTENZA ASSORBITA / ABSORBED POWER

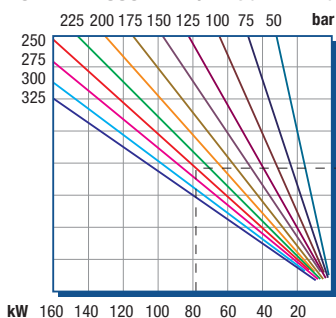

PORTATA / CAPACITY

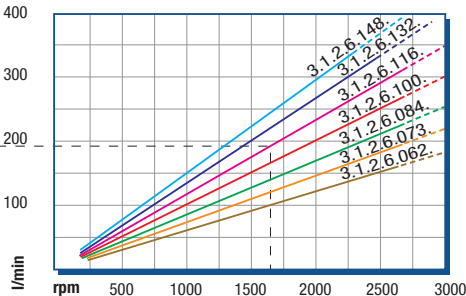

RILIEVI ESEGUITI CON OLIO
ISO VG 46 A 50° C (ν=30 cSt)
THE ABOVE SPECIFICATIONS
REFER TO OIL TYPE ISO
VG 46 AT 50° C (ν=30 cSt)

DIAGRAMMI / DIAGRAMS

RENDIMENTO VOLUMETRICO / VOLUMETRIC EFFICIENCY

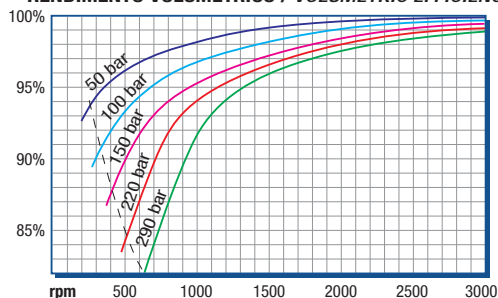

COPPIA ASSORBITA / INPUT TORQUE

