

## DIN 5482

**NEW**

CODICE DI ORDINAZIONE / ORDERING CODE

**200 HPS XXX X 0**

TIPO / TYPE  
POMPA AD INGRANAGGI / GEAR PUMP

CILINDRATA / DISPLACEMENT

DIN 5482

ROTAZIONE / ROTATION  
D = DESTRO / CLOCKWISE  
S = SINISTRO / ANTICLOCKWISE

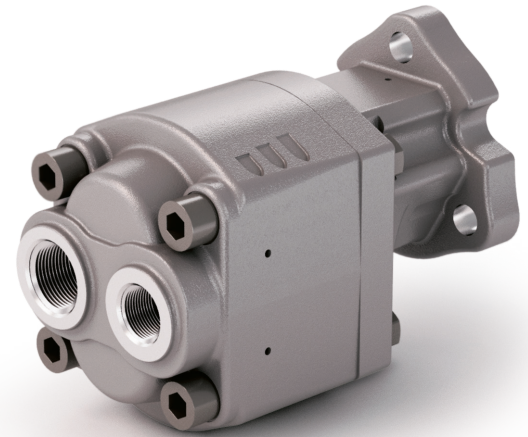

**MONODIREZIONALE  
MONO-ROTATIONAL**



**HPS 13**

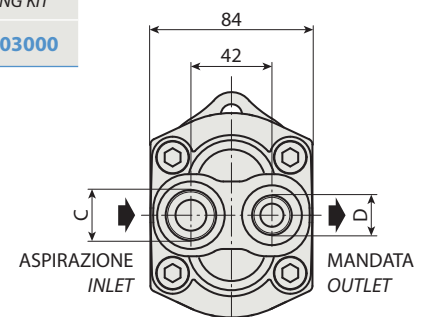
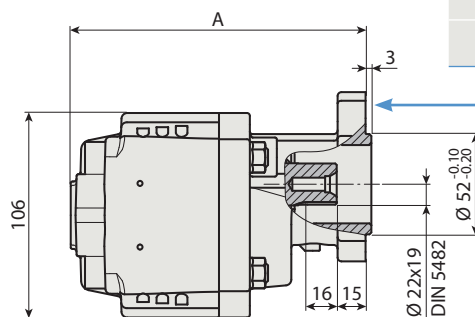
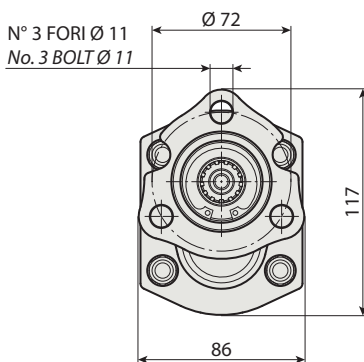

### CARATTERISTICHE E DATI TECNICI / SPECIFICATIONS AND TECHNICAL DATA

TIPO TYPE	CODICE / CODE		CILINDRATA DISPLACEMENT cm <sup>3</sup> /rev.	A mm	C ASPIRAZIONE INLET	D MANDATA OUTLET	PESO WEIGHT kg
	ROTAZIONE DESTRA CLOCKWISE ROT.	ROTAZIONE SINISTRA ANTICLOCKWISE ROT.					
<b>HPS 13</b>	<b>200HPS013D0</b>	<b>200HPS013S0</b>	13.5	142.0	3/4" G	1/2" G	4.8

KIT RASAMENTI / THRUST PLATES KIT CODICE / CODE 20602200000

KIT GUARNIZIONI COMPLETO / COMPLETE SEALS KIT CODICE / CODE 21904100000

Per la scelta dei raccordi orientabili vedi pag. 212-213 / For the selection of adjustable fittings see page 212-213

- A richiesta possono essere fornite le pompe ad ingranaggi con le guarnizioni HNBR per climi freddi (-40 °C).
- On request our gear pumps may be supplied with HNBR seals for cold climates (-40 °C).

TIPO / TYPE			HPS 13
Cilindrata <i>Displacement</i>	Vg	cm <sup>3</sup> /n cm <sup>3</sup> /rev.	13.5
Pressione massima continua <i>Max continuous operating pressure</i>	P1		280
Pressione massima intermittente <i>Max intermittent operating pressure</i>	(max 30 s) P2	bar	310
Pressione massima di picco <i>Max peak pressure</i>	(≤ 0.1 s) P3		320
Velocità massima intermittente <i>Max intermittent speed</i>	(P ≤ 20 bar) n3		2700
Velocità massima continua <i>Max continuous speed</i>	(≤ P1) n1	n/min r.p.m.	2200
Velocità minima intermittente <i>Min intermittent speed</i>	(≤ P2 x 0.5) (max 30 s) n4		450

1

**DIAGRAMMI / DIAGRAMS**

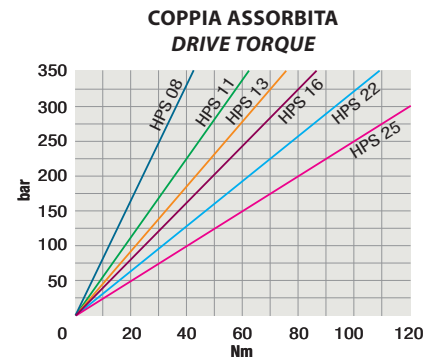
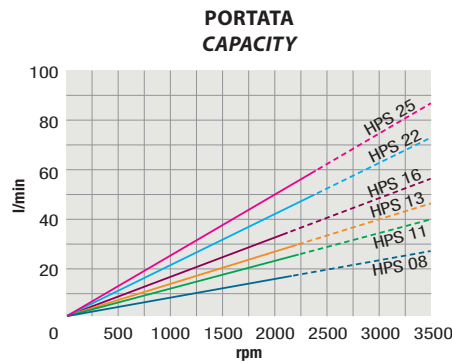
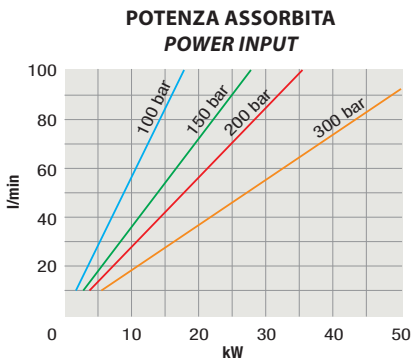

RILIEVI ESEGUITI CON OLIO ISO VG 46 A 50° C ( $\nu=30$  cSt)  
THE ABOVE SPECIFICATIONS REFER TO OIL TYPE ISO VG 46 AT 50° C ( $\nu=30$  cSt)

**ROTAZIONE POMPA / PUMP ROTATION**

