

## 21 UNI 222

CODICE DI ORDINAZIONE / ORDERING CODE

### 200 FZH XXX X 0

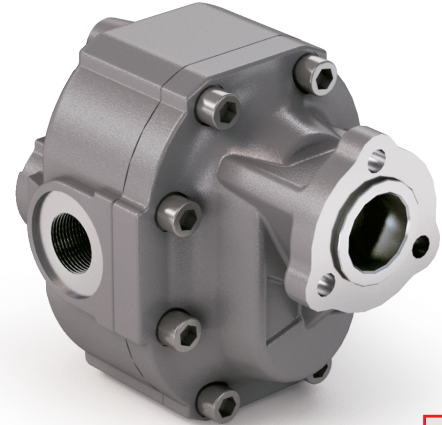
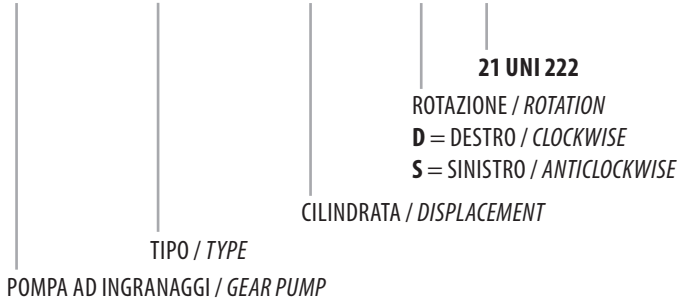

**FZH 116**

KIT ACCOPPIAMENTO POMPA UNI/PTO UNI  
COUPLING KIT UNI PUMP/UNI PTO

**198KPP02000**

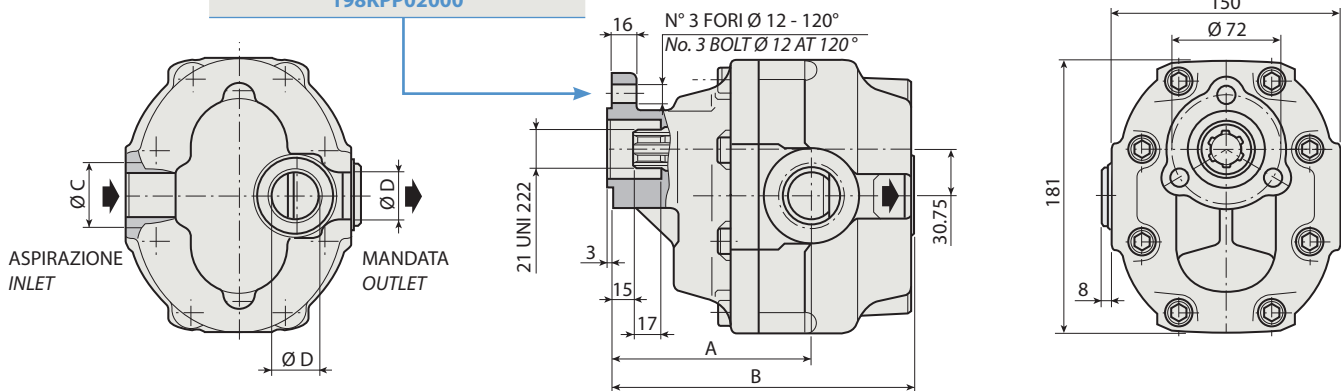

### CARATTERISTICHE E DATI TECNICI / SPECIFICATIONS AND TECHNICAL DATA

TIPO TYPE	CODICE / CODE		CILINDRATA DISPLACEMENT cm <sup>3</sup> /rev.	A mm	B mm	C ASPIRAZIONE INLET	D MANDATA OUTLET	PESO WEIGHT kg
	ROTAZIONE DESTRA CLOCKWISE ROT.	ROTAZIONE SINISTRA ANTICLOCKWISE ROT.						

<b>FZH 116</b>	<b>200FZH116D0</b>	<b>200FZH116S0</b>	<b>116</b>	<b>139</b>	<b>210</b>	<b>1" 1/4 G</b>	<b>1" G</b>	<b>19</b>
----------------	--------------------	--------------------	------------	------------	------------	-----------------	-------------	-----------

KIT RASAMENTI / THRUST PLATES KIT CODICE / CODE 2H451075000

KIT GUARNIZIONI COMPLETO / COMPLETE SEALS KIT CODICE / CODE 21901400000

Per la scelta dei raccordi orientabili vedi pag. 212-213 / For the selection of adjustable fittings see page 212-213

- A richiesta possono essere fornite le pompe ad ingranaggi con le guarnizioni HNBR per climi freddi (-40 °C).
- On request our gear pumps may be supplied with HNBR seals for cold climates (-40 °C).

TIPO / TYPE		
Cilindrata <i>Displacement</i>	Vg	cm <sup>3</sup> /n cm <sup>3</sup> /rev.
Pressione massima continua <i>Max continuous operating pressure</i>	P1	
Pressione massima intermittente <i>Max intermittent operating pressure</i>	(max 30 s) P2	bar
Pressione massima di picco <i>Max peak pressure</i>	(≤ 0.1 s) P3	
Velocità massima intermittente <i>Max intermittent speed</i>	(P ≤ 20 bar) n3	
Velocità massima continua <i>Max continuous speed</i>	(≤ P1) n1	n/min r.p.m.
Velocità minima intermittente <i>Min intermittent speed</i>	(≤ P2 x 0.5) (max 30 s) n4	

FZH 116
116
240
260
340
3000
1500
250

**DIAGRAMMI / DIAGRAMS**

**POTENZA ASSORBITA**  
**POWER INPUT**

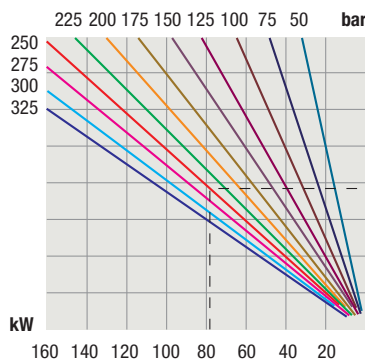

**PORTATA**  
**CAPACITY**

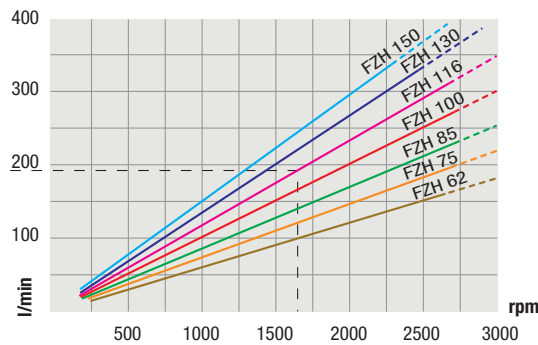

**RENDIMENTO VOLUMETRICO**  
**VOLUMETRIC EFFICIENCY**

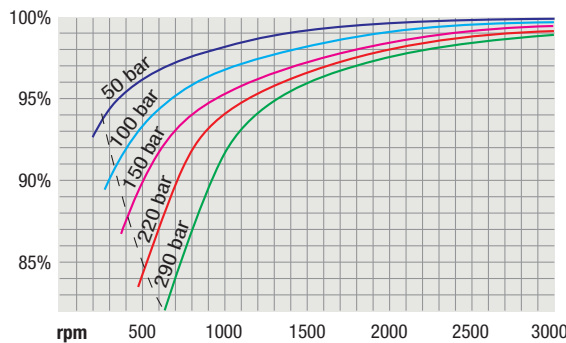

**COPPIA ASSORBITA**  
**DRIVE TORQUE**

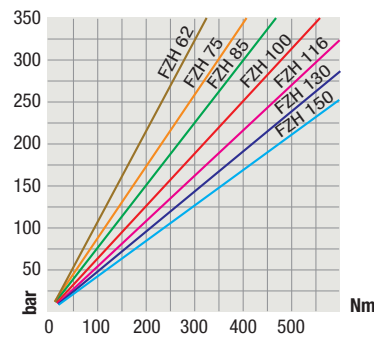

RILIEVI ESEGUITI CON OLIO ISO VG 46 A 50° C ( $\nu = 30$  cSt)  
THE ABOVE SPECIFICATIONS REFER TO OIL TYPE ISO VG 46 AT 50° C ( $\nu = 30$  cSt)