

21 UNI 222

CODICE DI ORDINAZIONE / ORDERING CODE

200 FZO XXX X 0

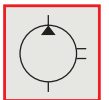
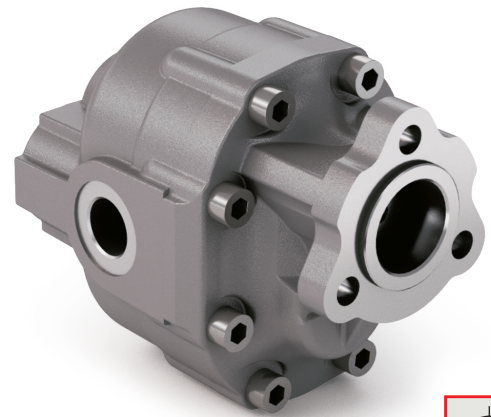
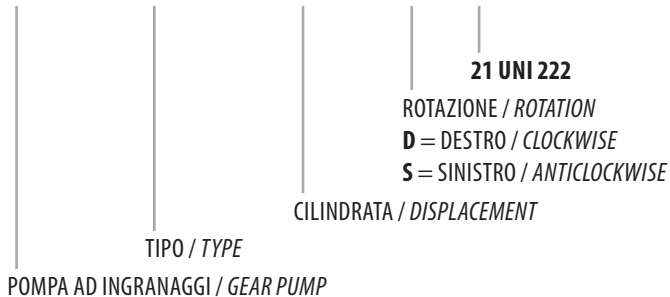

1

FZO 110

KIT ACCOPIAMENTO POMPA UNI/PTO UNI
COUPLING KIT UNI PUMP/UNI PTO
198KPP02000

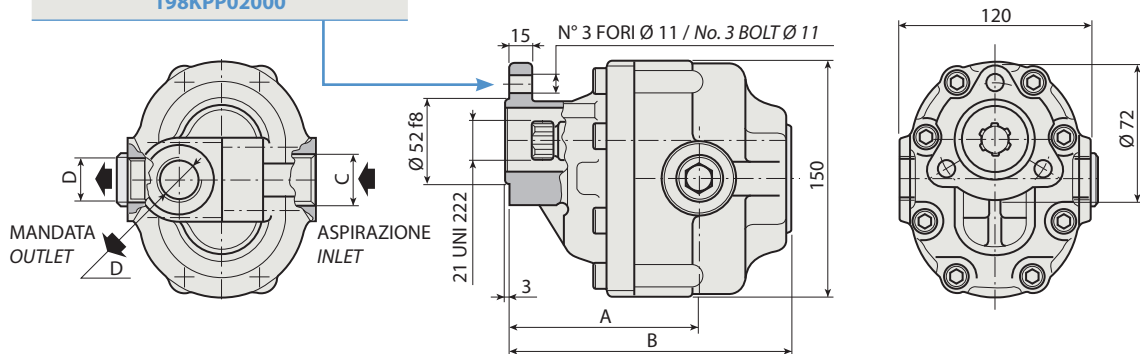

CARATTERISTICHE E DATI TECNICI / SPECIFICATIONS AND TECHNICAL DATA

TIPO TYPE	CODICE / CODE		CILINDRATA DISPLACEMENT cm ³ /rev.	A mm	B mm	C ASPIRAZIONE INLET	D MANDATA OUTLET	PESO WEIGHT kg
	ROTAZIONE DESTRA CLOCKWISE ROT.	ROTAZIONE SINISTRA ANTICLOCKWISE ROT.						

FZO 110	200FZO110D0	200FZO110S0	105	138	204.5	1" 1/4 G	1" G	13.7
----------------	--------------------	--------------------	------------	------------	--------------	-----------------	-------------	-------------

KIT RASAMENTI / THRUST PLATES KIT CODICE / CODE 20601800000

KIT GUARNIZIONI COMPLETO / COMPLETE SEALS KIT CODICE / CODE 21901000000

Per la scelta dei raccordi orientabili vedi pag. 212-213 / For the selection of adjustable fittings see page 212-213

- A richiesta possono essere fornite le pompe ad ingranaggi con le guarnizioni HNBR per climi freddi (-40 °C).
- On request our gear pumps may be supplied with HNBR seals for cold climates (-40 °C).

TIPO / TYPE		
Cilindrata <i>Displacement</i>	Vg	cm ³ /n cm ³ /rev.
Pressione massima continua <i>Max continuous operating pressure</i>	P1	
Pressione massima intermittente <i>Max intermittent operating pressure</i> (max 30 s)	P2	bar
Pressione massima di picco <i>Max peak pressure</i> (≤ 0.1 s)	P3	
Velocità massima intermittente <i>Max intermittent speed</i> (P ≤ 20 bar)	n3	
Velocità massima continua <i>Max continuous speed</i> (≤ P1)	n1	n/min r.p.m.
Velocità minima intermittente <i>Min intermittent speed</i> (≤ P2 x 0.5) (max 30 s)	n4	

FZO 110

105

180

200

250

3000

1500

300

DIAGRAMMI / DIAGRAMS

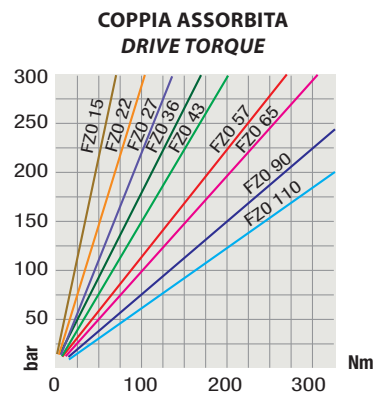
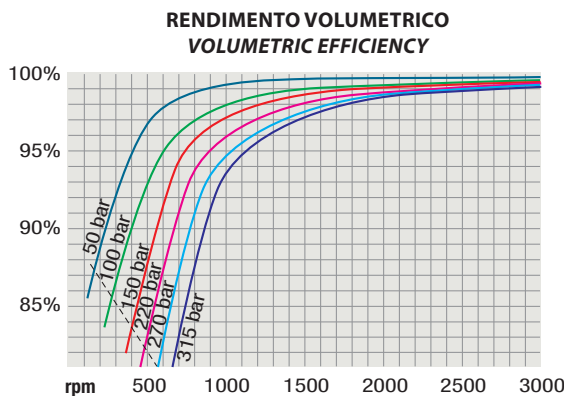
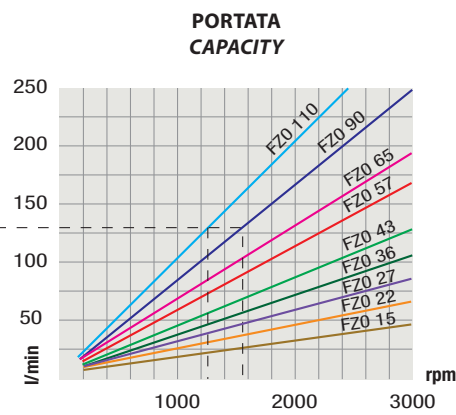
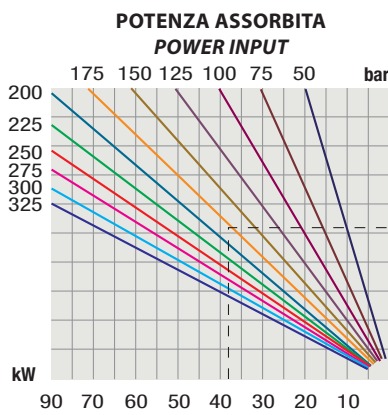

RILIEVI ESEGUITI CON OLIO ISO VG 46 A 50° C ($\nu = 30$ cSt)
THE ABOVE SPECIFICATIONS REFER TO OIL TYPE ISO VG 46 AT 50° C ($\nu = 30$ cSt)