

DIN 5482

NEW

CODICE DI ORDINAZIONE / ORDERING CODE

200 HPS XXX X 0

TIPO / TYPE
POMPA AD INGRANAGGI / GEAR PUMP

CILINDRATA / DISPLACEMENT

DIN 5482

ROTAZIONE / ROTATION
D = DESTRO / CLOCKWISE
S = SINISTRO / ANTICLOCKWISE

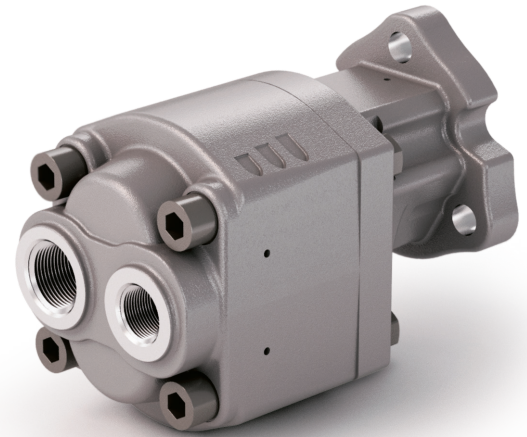

**MONODIREZIONALE
MONO-ROTATIONAL**



HPS 08

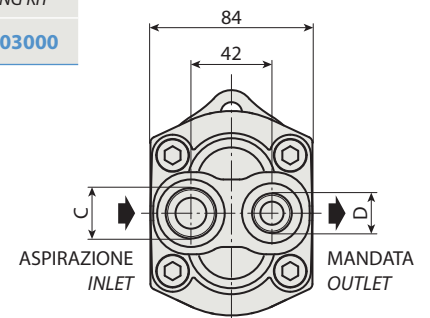
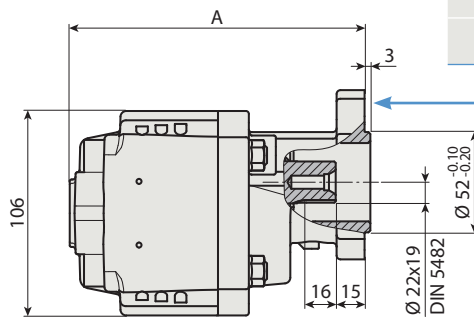
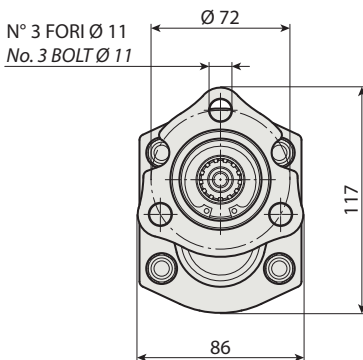

CARATTERISTICHE E DATI TECNICI / SPECIFICATIONS AND TECHNICAL DATA

TIPO TYPE	CODICE / CODE		CILINDRATA DISPLACEMENT cm ³ /rev.	A mm	C ASPIRAZIONE INLET	D MANDATA OUTLET	PESO WEIGHT kg
	ROTAZIONE DESTRA CLOCKWISE ROT.	ROTAZIONE SINISTRA ANTICLOCKWISE ROT.					
HPS 08	200HPS008D0	200HPS008S0	8.3	131.7	3/4" G	1/2" G	4.2

KIT RASAMENTI / THRUST PLATES KIT CODICE / CODE 20602200000

KIT GUARNIZIONI COMPLETO / COMPLETE SEALS KIT CODICE / CODE 21904100000

Per la scelta dei raccordi orientabili vedi pag. 212-213 / For the selection of adjustable fittings see page 212-213

- A richiesta possono essere fornite le pompe ad ingranaggi con le guarnizioni HNBR per climi freddi (-40 °C).
- On request our gear pumps may be supplied with HNBR seals for cold climates (-40 °C).

TIPO / TYPE		HPS 08	
Cilindrata <i>Displacement</i>	Vg	cm ³ /n cm ³ /rev.	8.3
Pressione massima continua <i>Max continuous operating pressure</i>	P1		280
Pressione massima intermittente <i>Max intermittent operating pressure</i>	(max 30 s) P2	bar	310
Pressione massima di picco <i>Max peak pressure</i>	(≤ 0.1 s) P3		320
Velocità massima intermittente <i>Max intermittent speed</i>	(P ≤ 20 bar) n3		2700
Velocità massima continua <i>Max continuous speed</i>	(≤ P1) n1	n/min r.p.m.	2200
Velocità minima intermittente <i>Min intermittent speed</i>	(≤ P2 x 0.5) (max 30 s) n4		450

1

DIAGRAMMI / DIAGRAMS

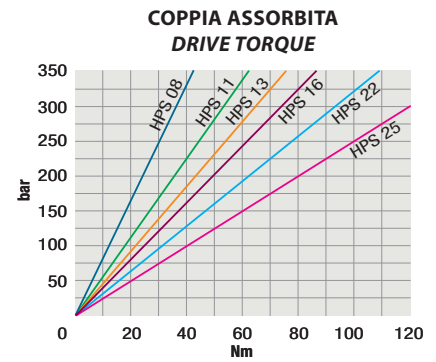
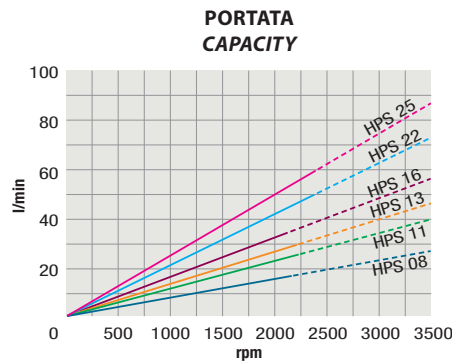
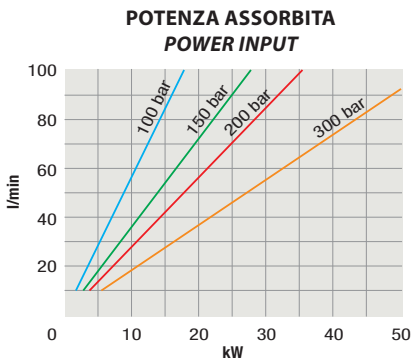

RILIEVI ESEGUITI CON OLIO ISO VG 46 A 50° C ($\nu=30$ cSt)
THE ABOVE SPECIFICATIONS REFER TO OIL TYPE ISO VG 46 AT 50° C ($\nu=30$ cSt)

ROTAZIONE POMPA / PUMP ROTATION

