

SERIE **EOS**
**3.1.7.0.**

CODICE DI ORDINAZIONE / DECODING

**3.1.7.0 . XXX . X . X . 00**

ROTAZIONE/ROTATION  
 1 = SINISTRO/ANTICLOCKWISE  
 2 = DESTRO/CLOCKWISE  
 1 = UNI 3 FORI/3 HOLES UNI  
 2 = DIN 4 FORI/4 HOLES DIN  
 CILINDRATA/DISPLACEMENT

**UNI**

21-222

EOS 25

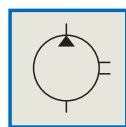
**Pompa a Pistoni**  
*Piston Pump*

CODICE BASE/BASIC CODE

TIPO / TYPE	CODICE / CODE
EOS 25	3.1.7.0.025.X.X.00

**CARATTERISTICHE E DATI TECNICI / SPECIFICATIONS AND TECHNICAL DATA**

TIPO / TYPE				EOS 25
Cilindrata <i>Displacement</i>	Vg	cm <sup>3</sup> /n cm <sup>3</sup> /rev.		25.61
Pressione massima <i>Max operating pressure</i>	P1	bar		450
Pressione massima di picco <i>Max peak pressure</i> (≤ 0.1 s)	P3		500	
Velocità massima intermittente <i>Max intermittent speed</i> (P ≤ 30 bar)	n3	n/min r.p.m.		3000
Velocità massima continua <i>Max continuous speed</i> (≤ P1)	n1		2300	
Velocità minima intermittente <i>Min intermittent speed</i> (≤ P1 x 0.5) (max 30 s)	n4		300	
Pressione in aspirazione (assoluta) <i>Suction pressure (absolute)</i>	P	bar	0.7 ÷ 1.5	
Campo di viscosità lavoro <i>Operating viscosity range</i>	√	cST	9 ÷ 75	
Campo di viscosità ottimale <i>Optimal viscosity range</i>	√		15 ÷ 46	
Massima viscosità avviamento <i>Start up max viscosity</i>	√		1000	
Temperatura fluido °C (t) <i>Fluid temperature °C (t)</i>	t	°C	-25° ÷ 80°	

DIMENSIONI / DIMENSIONS

UNI

21-222

3 FORI  
3 HOLES

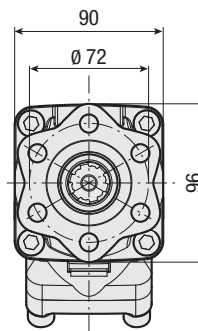
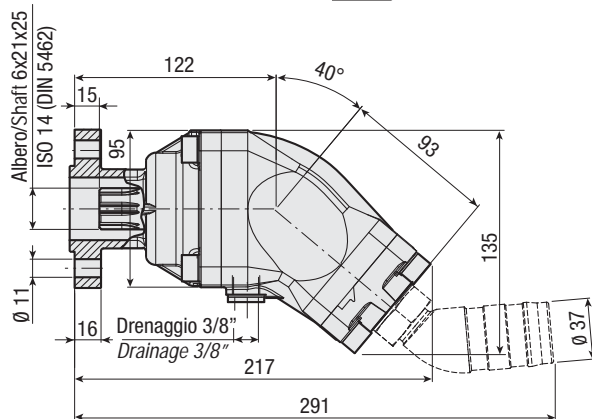
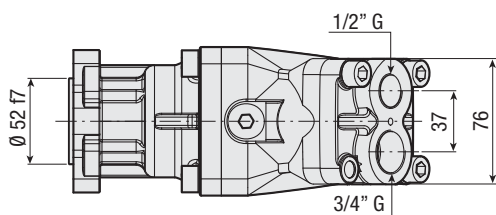

SERIE EOS 3170.

POMPE A PISTONI PISTON PUMPS

2

# SERIE EOS 3.1.7.0.

EOS 12  
EOS 16  
EOS 25

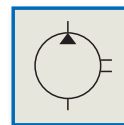

## DIAGRAMMI / DIAGRAMS

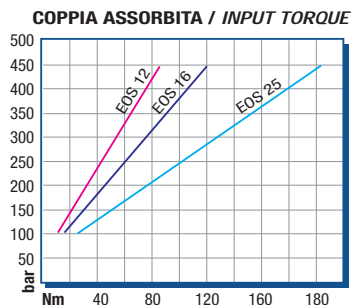
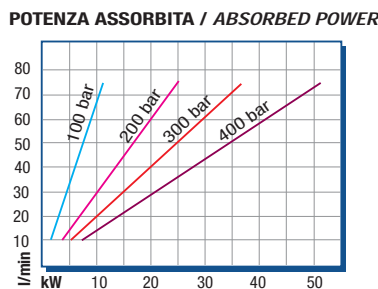
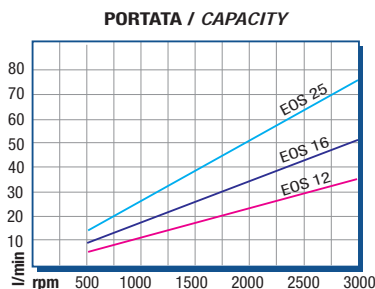

RILIEVI ESEGUITI CON OLIO  
ISO VG 46 A 50° C ( $\nu=30$  cSt)  
THE ABOVE SPECIFICATIONS  
REFER TO OIL TYPE ISO  
VG 46 AT 50° C ( $\nu=30$  cSt)

## FILTRAZIONE / FILTERING

> Si raccomanda filtrazione sul ritorno (o mandata) come da tabella a lato.

La filtrazione in aspirazione è sconsigliata in quanto può generare fenomeni di cavitazione. Qualora si rendesse indispensabile, rispettare i valori limite di depressione previsti di -0,3 bar (corrispondente a 0,7 bar assoluti).

> *Filtering on return line (or outlet) recommended. Refer to the side table.*

*A filter on the inlet is not recommended because of possible cavitation problems. If it is necessary, the suction pressure limit of -0,3 bar (corresponding to 0,7 absolute bar) must be respected.*

Pressione Lavoro Working Press. p <sub>2</sub>	Contaminazione / Contamination		Filtro / Filter $\beta_x = 75$
	NAS 1638	ISO 4406	
≤ 200 bar	10	19/16	25 μm
< 300 bar	9	18/15	20 μm
≥ 300 bar	8	17/14	10 μm

## RACCORDERIA / FITTINGS

> Avvitare sulla pompa raccordi GAS-CILINDRICO (BSP) a tenuta frontale. **NON** applicare raccordi con filettatura conica.

> *Make use of cylindric gas-fittings (BSP) with O-ring, bonded-seal on the pump. Do NOT use fittings with conical thread.*

**NORME PER L'INSTALLAZIONE / INSTALLATION INSTRUCTIONS**

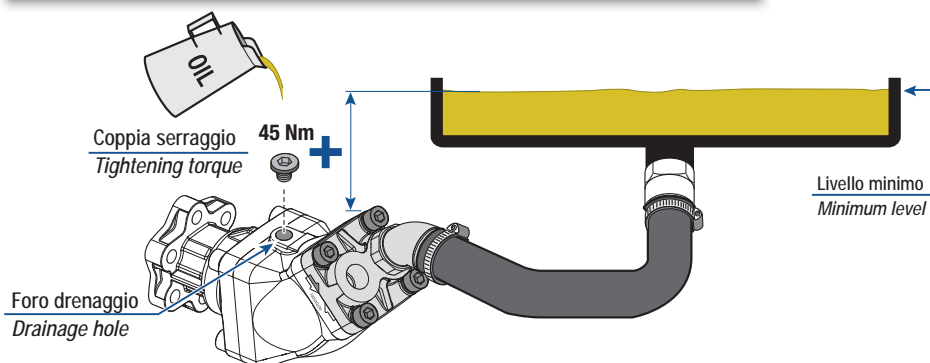

PRIMA DELL'AVVIAMENTO ASSICURARSI CHE LA POMPA SIA RIEMPITA D'OLIO O SPURGANDO L'ARIA DAL TAPPO DI DRENAGGIO O RIEMPENDOLA PREVENTIVAMENTE.

BEFORE STARTING UP MAKE SURE THAT THE PUMP IS FILLED WITH OIL, EITHER BY BLEEDING THE AIR THROUGH THE DRAINAGE HOLE OR BY FILLING THE PUMP PREVIOUSLY.

Il mancato rispetto della norma può provocare danneggiamenti alla pompa.  
Failing to observe this rule may cause damages to the pump.

**SENSO DI ROTAZIONE-CAMBIO ROTAZIONE / DIRECTION OF ROTATION-CHANGE OF ROTATION**

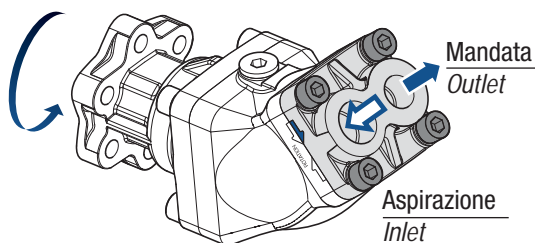

Determinazione senso di rotazione.

Choosing the direction of rotation.

POMPA ROTAZIONE DESTRA  
(P.T.O. ROTAZIONE SINISTRA)

CLOCKWISE ROTATING PUMP  
(ANTICLOCKWISE ROTATING P.T.O.)

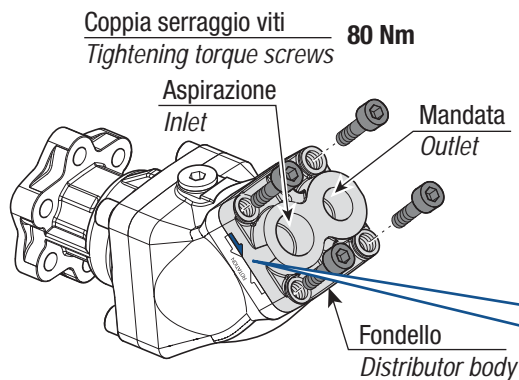

Per invertire il senso di rotazione, togliere le 4 viti e, tenendo accostato il fondello, ruotarlo di 180°. Serrare le 4 viti a 80 ± 5 Nm.

To change the direction of rotation remove the 4 screws and, keeping the distributor body close to the pump, rotate it by 180°. Tighten the 4 screws at 80 ± 5 Nm.

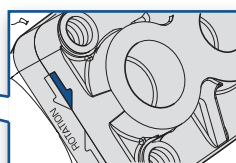

**FRECCIA + TACCA = SENSO DI ROTAZIONE**

**ARROW + NOTCH = DIRECTION OF ROTATION**

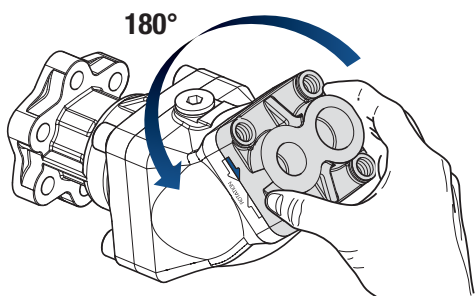

**ATTENZIONE:**  
durante l'operazione il fondello non deve mai distaccarsi dal corpo pompa per più di 2 mm.

**WARNING:**  
during this operation the distributor body must not move away from the pump body more than 2 mm.

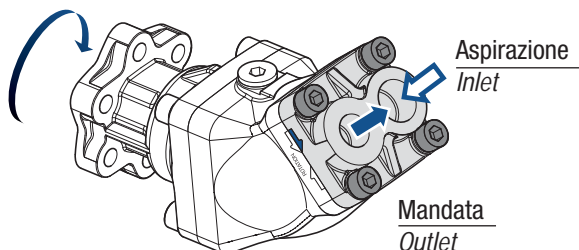

POMPA ROTAZIONE SINISTRA  
(P.T.O. ROTAZIONE DESTRA)

ANTICLOCKWISE ROTATING PUMP  
(CLOCKWISE ROTATING P.T.O.)