

*Closed*

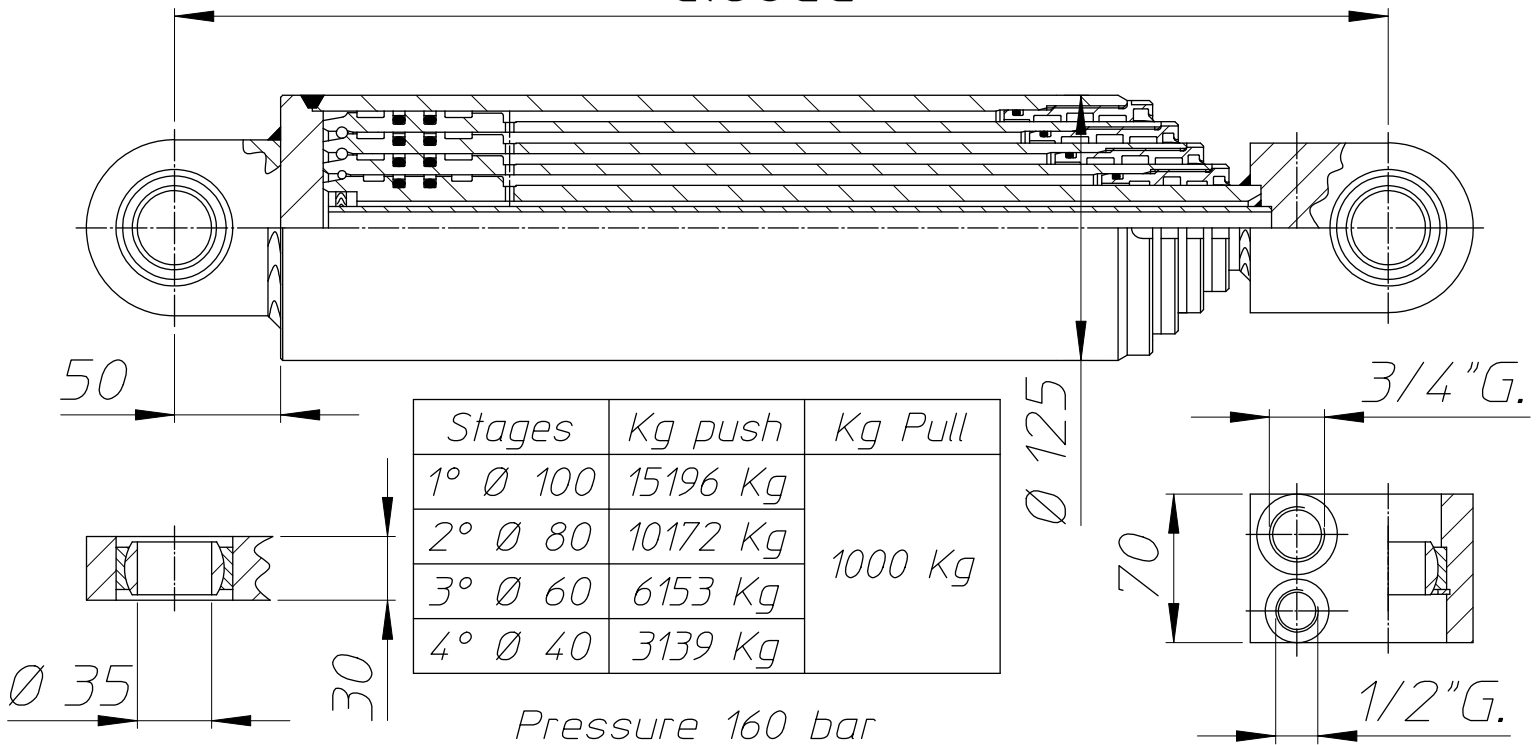

<i>Code</i>	<i>Closed</i>	<i>Stroke</i>	<i>Tot. Open</i>
T44/160/500	500	750	1250
T44/160/550	550	950	1500
T44/160/600	600	1150	1750
T44/160/650	650	1350	2000
T44/160/700	700	1550	2250
T44/160/750	750	1750	2500
T44/160/800	800	1950	2750
T44/160/850	850	2150	3000
T44/160/900	900	2350	3250
T44/160/950	950	2550	3500
T44/160/1000	1000	2750	3750
T44/160/1050	1050	2950	4000
T44/160/1100	1100	3150	4250
T44/160/1150	1150	3350	4500
T44/160/1200	1200	3550	4750
T44/160/1250	1250	3750	5000
T44/160/1300	1300	3950	5250
T44/160/1350	1350	4000	5350
T44/160/1400	1400	4200	5600
T44/160/1450	1450	4300	5750

*We also supply if you need middle dimensions*