

	<b>Output 1</b>	<b>Output 2</b>	<b>Number of teeth</b>	12
<b>Torque (Nm)</b>	350	350	<b>Module</b>	3,25
<b>Int. ratio</b>	1,8	1,8	<b>Replace</b>	
<b>Number of axles</b>	2	2	<b>Replaced by</b>	

11/01/2017

### Command type

Electric    
  Hydraulic    
  Mechanical    
  Fixed engagement    
  Pneumatic    
  Vacuum system

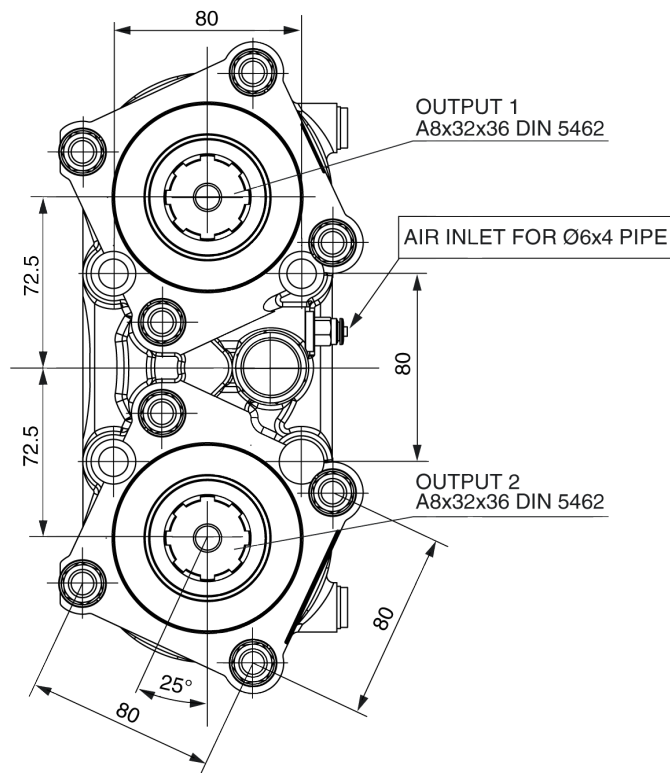
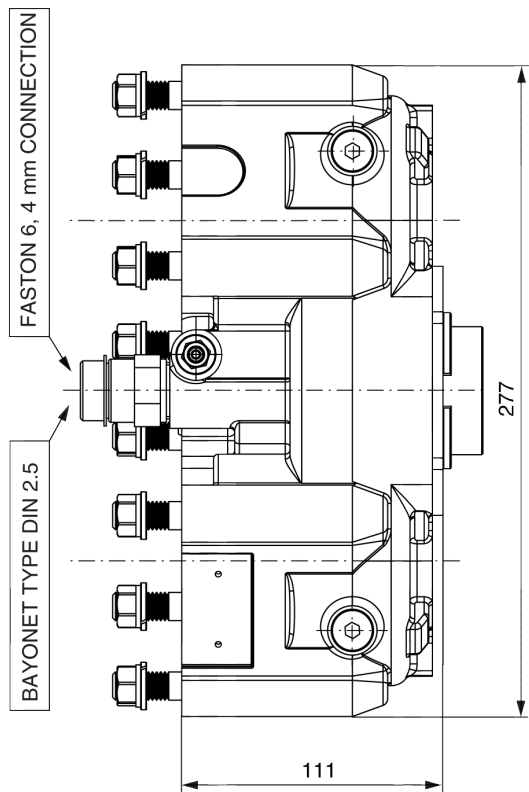

VEHICLE MOTION DIRECTION

