

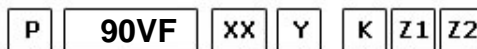

#PTO POS. H. D. D.U. VOLVO VT CON RETARDER

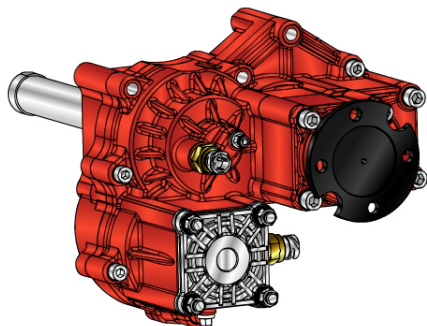

- Outlet version
- Outlet control option
- Available option
- Control option
- Model
- PTO

	Output 1	Output 2	Number of teeth	12
Torque (Nm)	800	500	Module	3,25
Int. ratio	1,45	1,94	Replace	904
Number of axles	2	2	Replaced by	

31/01/2014

Command type

- Electric
 Hydraulic
 Mechanical
 Fixed engagement
 Pneumatic
 Vacuum system

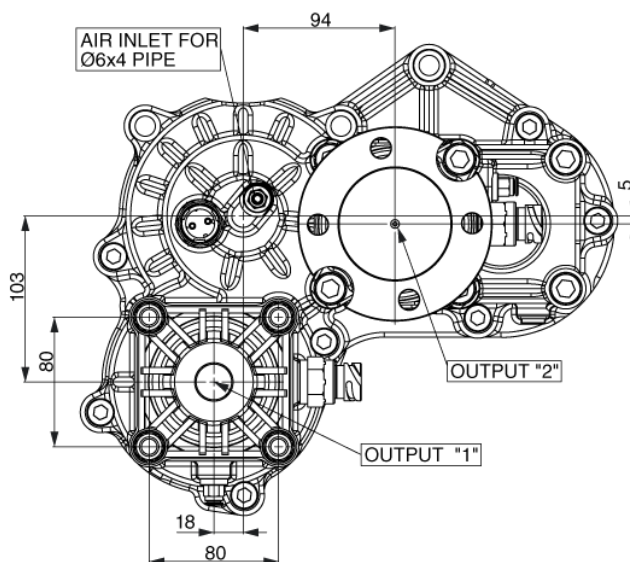
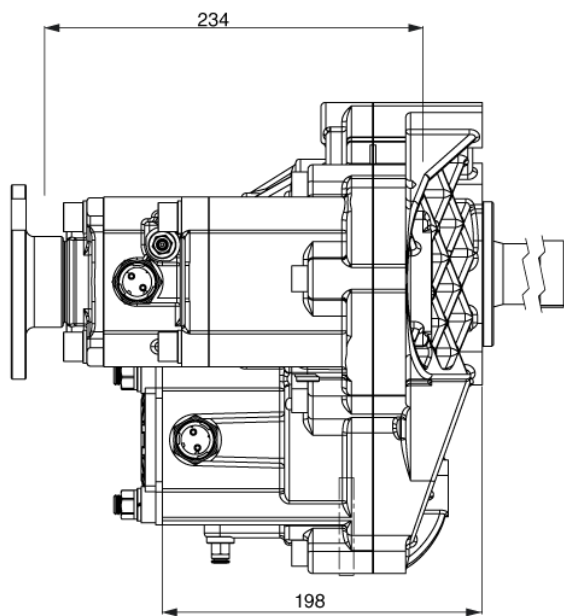

VEHICLE MOTION DIRECTION

