

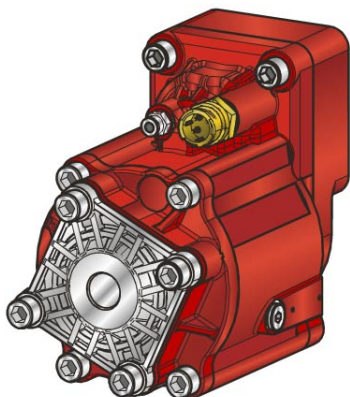

#PTO POS. M. D. Z.F 6.80 - 16S221



P	87Z1	XX	Y	ZZZ
---	------	----	---	-----

Outlet version
Available option
Control option
Model
PTO

	Output 1		Number of teeth	12
Torque (Nm)	350		Module	3,25
Int. ratio	1,8		Replace	
Number of axles	2		Replaced by	

11/01/2017

Command type

Electric Hydraulic Mechanical Fixed engagement Pneumatic Vacuum system

