

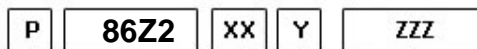

#PTO POS. M. D. Z.F 6.80 - 16S221

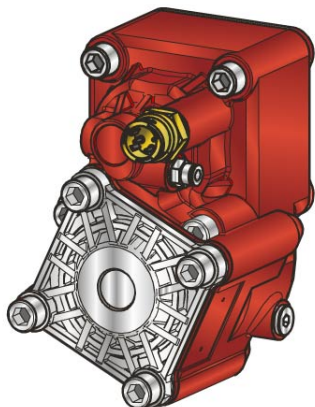

Outlet version
 Available option
 Control option
 Model
 PTO

	Output 1		Number of teeth	12
Torque (Nm)	400		Module	3,25
Int. ratio	1,58		Replace	
Number of axles	2		Replaced by	

22/03/2011

Command type

Electric Hydraulic Mechanical Fixed engagement Pneumatic Vacuum system

