

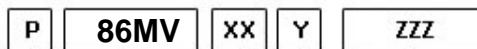

#PTO POS. M. D. MERCEDES G211

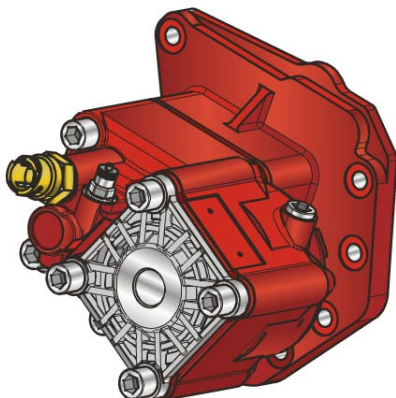

Outlet version
 Available option
 Control option
 Model
 PTO

	Output 1		Number of teeth	12
Torque (Nm)	500		Module	3
Int. ratio	0,92		Replace	
Number of axles	2		Replaced by	

Command type

Electric Hydraulic Mechanical Fixed engagement Pneumatic Vacuum system

