

Outlet version
Available option
Control option
Model
PTO

	Output 1		Number of teeth	23
Torque (Nm)	230		Module	3,35
Int. ratio	1,04		Replace	
Number of axles	2		Replaced by	

06/03/2018

Command type

Electric Hydraulic Mechanical Fixed engagement Pneumatic Vacuum system

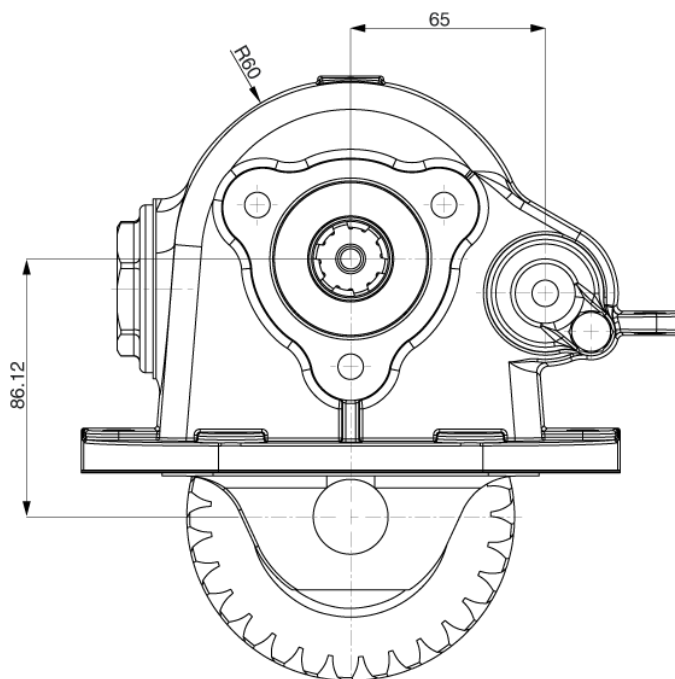
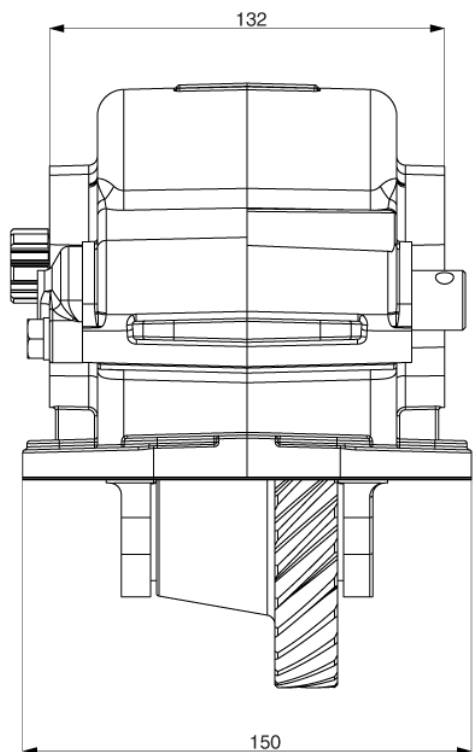

VEHICLE MOTION DIRECTION

