

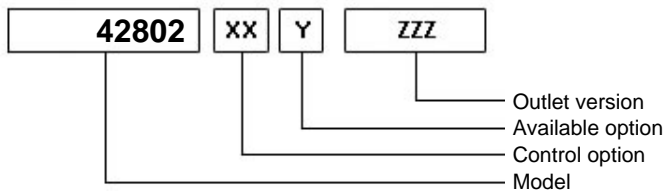

# PZB®

D01P-0-03 - Pagina WebPTO PZB - rev. 0

# 42802



	<b>Output 1</b>		<b>Number of teeth</b>	28
<b>Torque (Nm)</b>	250		<b>Module</b>	3,5
<b>Int. ratio</b>	1,33		<b>Replace</b>	
<b>Number of axles</b>	2		<b>Replaced by</b>	

21/09/2006

### Command type

- [X] Mechanical with lever remote control (TC)    [] Hydraulic control    [] Pneumatic
- [] Ready for electric solenoid control    [X] Depressure control    [] Constantly engaged
- [X] Mechanical with PUSH-PULL remote control [X] Electric control KES 5    [] Ready for detached control

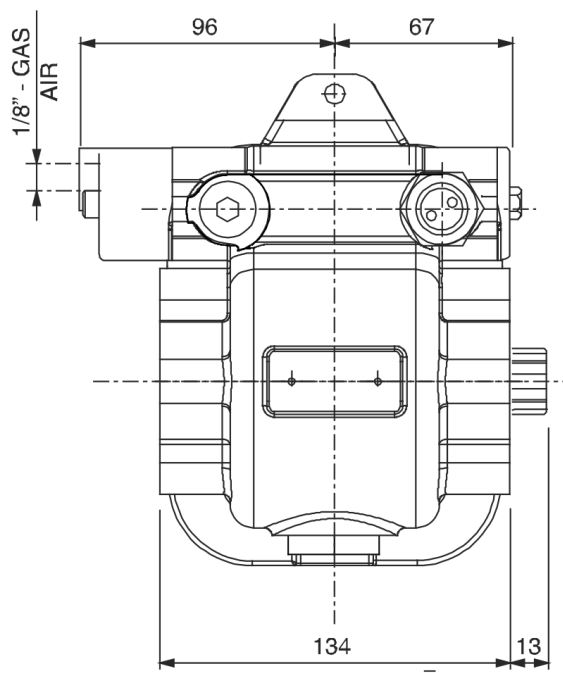
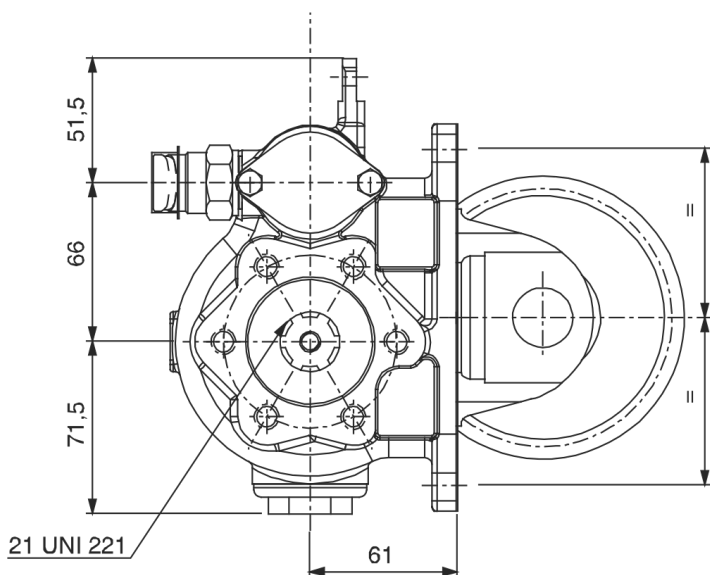

Interpump Hydraulics Spa a socio unico - **Business Unit PZB**

Sede Legale: via A. Mingozzi, 6 • 40012 Calderara di Reno BO - Italy

Sede Operativa: via A. Mingozzi, 6 • 40012 Calderara di Reno BO - Italy • T +39 051 6460511 • F +39 051 6460560 • info@pzbitaly.com • pzbitaly.com

Cap. Soc. Euro 2.631.600,00 i.v. • N. Mecc. BO 056383 • R.E.A. BO 444225 • C.F. 00883010241 • P.Iva IT02128140361

Soggetta ad attività di Direzione e Coordinamento da parte di Interpump Group Spa

