



# PZB®

D01P-0-03 - Pagina WebPTO PZB - rev. 0

## 427Z6



### #PTO POS. M. D. Z.F 5.35 - 6.36

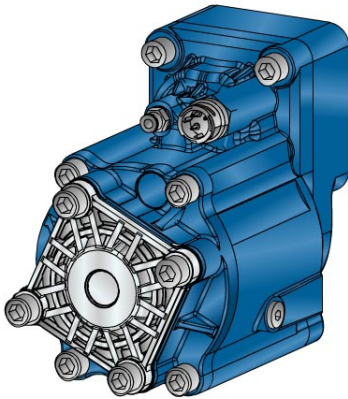

**427Z6** **XX** **Y** **ZZZ**

Outlet version  
Available option  
Control option  
Model

	<b>Output 1</b>		<b>Number of teeth</b>	12
<b>Torque (Nm)</b>	400		<b>Module</b>	3
<b>Int. ratio</b>	1,58		<b>Replace</b>	
<b>Number of axles</b>	2		<b>Replaced by</b>	

15/09/2006

### Command type

- Mechanical with lever remote control (TC)
- Ready for electric solenoid control
- Mechanical with PUSH-PULL remote control
- Hydraulic control
- Depressure control
- Electric control KES 5
- Pneumatic
- Constantly engaged
- Ready for detached control

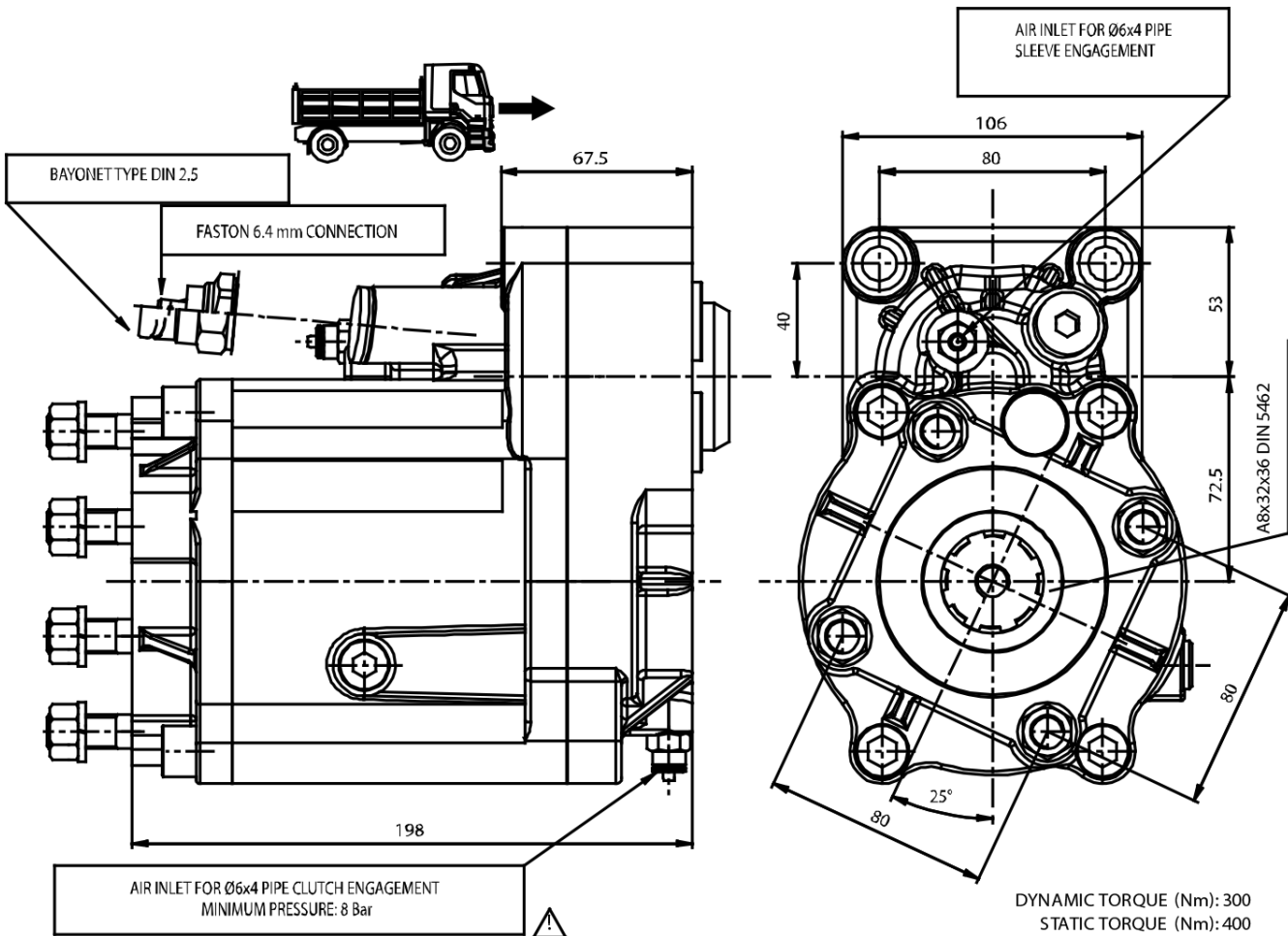

Interpump Hydraulics Spa a socio unico - **Business Unit PZB**

Sede Legale: via A. Mingozzi, 6 • 40012 Calderara di Reno BO - Italy

Sede Operativa: via A. Mingozzi, 6 • 40012 Calderara di Reno BO - Italy • T +39 051 6460511 • F +39 051 6460560 • info@pzbitaly.com • pzbitaly.com

Cap. Soc. Euro 2.631.600,00 i.v. • N. Mecc. BO 056383 • R.E.A. BO 444225 • C.F. 00883010241 • P.Iva IT02128140361

Soggetta ad attività di Direzione e Coordinamento da parte di Interpump Group Spa

