

Outlet version
Available option
Control option
Model
PTO

	Output 1	
Torque (Nm)	90	
Int. ratio	1,7	
Number of axles	2	

Number of teeth	34
Module	2,45
Replace	
Replaced by	

24/09/2014

Command type

Electric Hydraulic Mechanical Fixed engagement Pneumatic Vacuum system

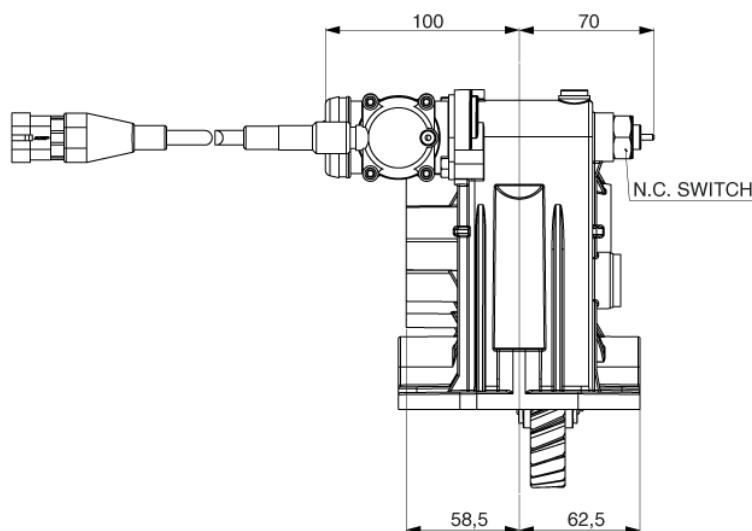

- GR. 1 INDUSTRIAL PUMP
- BPC GR.2 COMPACT PUMP
- STANDARD UNI 3 HOLES PUMP

