

2 way two line system knock-off valve.
Mechanically operated.
Delivery up to 100 litres/min.
Pressure max.: 350 bar.

WEIGHT: kg. 1,4

APPLICATION DIAGRAM

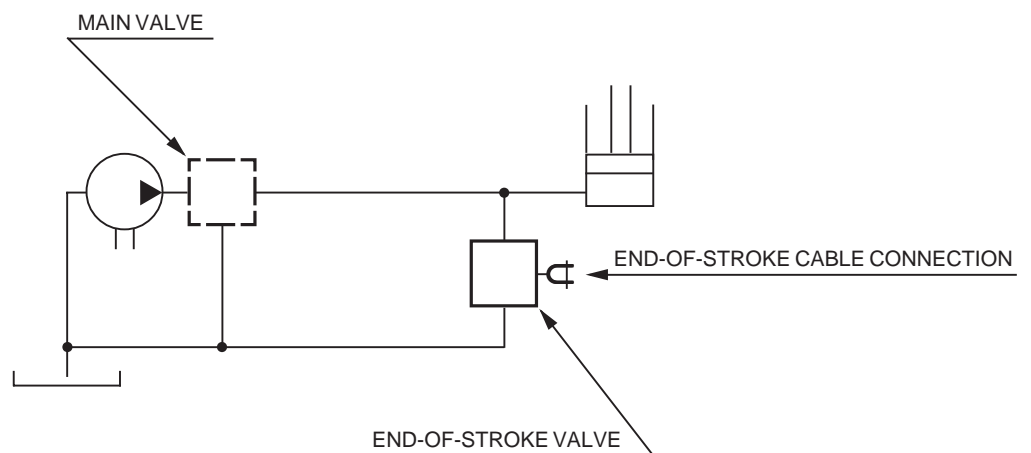

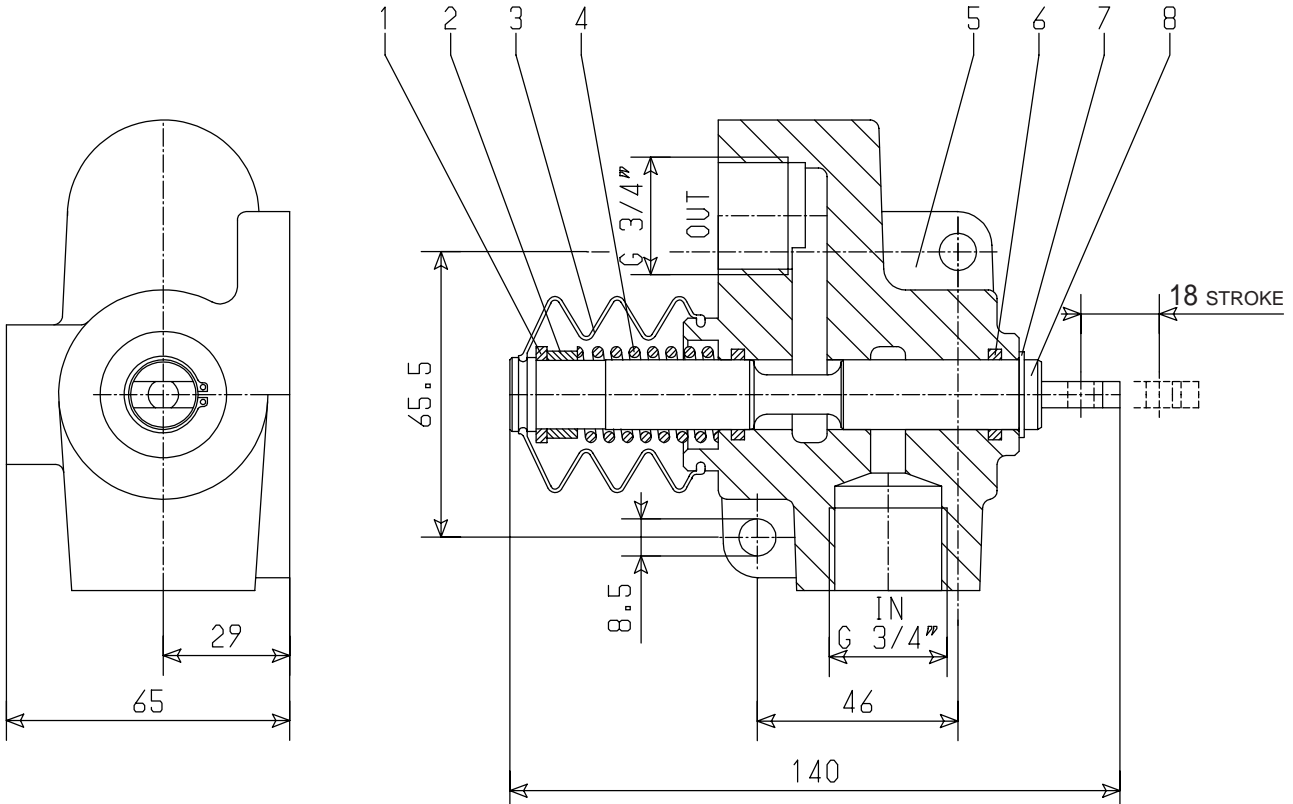

REF.	CODE	DESCRIPTION	QT.
1	1.27.02.062.00	Ring 3/8"-3/4"	1
2	1.26.01.101.00	Spacer	1
3	1.99.00.018.00	Rubber bellow DOP19/6	1
4	1.28.01.064.00	Coil spring	1
5	1.06.03.014.00	Body V.F.C. 3/4" RVL	1
6	0.08.02.031.00	O-Ring OR 121	2
7	0.07.01.014.00	Circlip 16e UNI 7435	1
8	1.15.00.051.00	Spool	1