

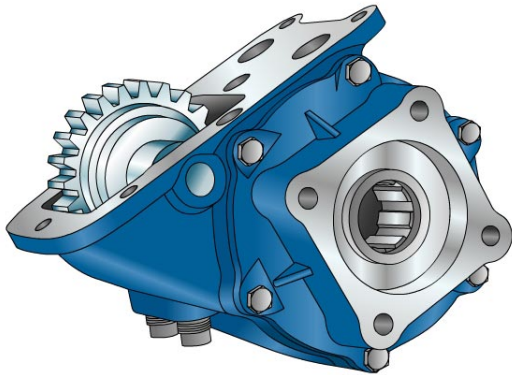

PZB®

D01P-0-03 - Pagina WebPTO PZB - rev. 0

32911



32911 **XX** **Y** **ZZZ**

Outlet version
Available option
Control option
Model

G 1/8"

AIR	Outlet 1	Number of teeth	22
Torque (Nm)	400	Module	4,23
Int. ratio	0,38	Replace	A8x32x36 DIN 5162
Number of axes	2	Replaced by	

13/10/2006

Command type

- Mechanical with lever remote control (TC)
- Ready for electric solenoid control
- Mechanical with PUSH-PULL remote control
- Hydraulic control
- Depressure control
- Electric control KES 5
- Pneumatic
- Constantly engaged
- Ready for detached control

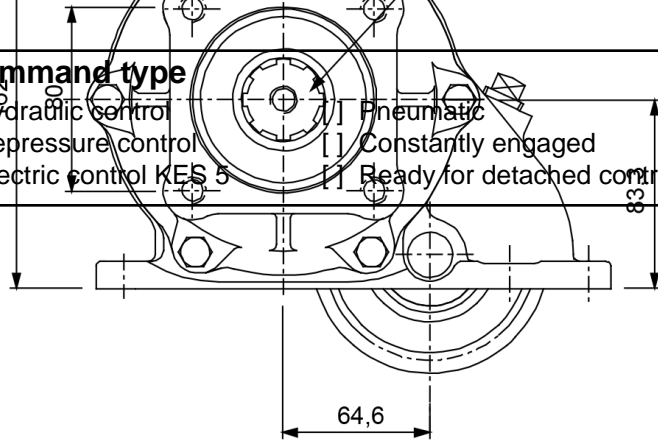
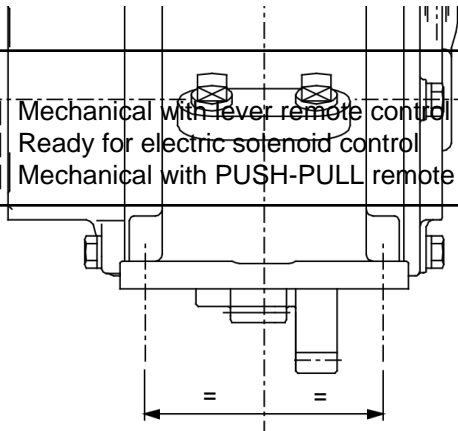

1

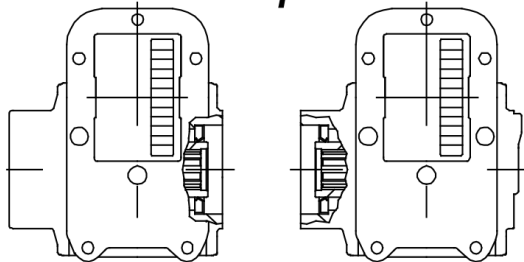

POSIZIONE INGRANAGGIO
GEAR POSITION

2

