

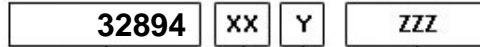

# PZB®

D01P-0-03 - Pagina WebPTO PZB - rev. 0

# 32894

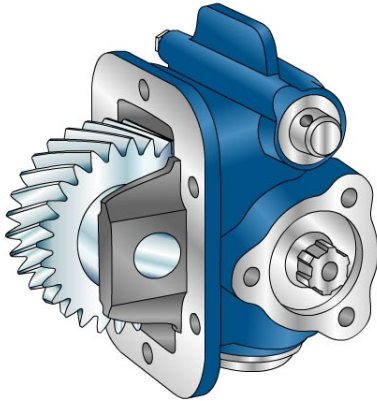

Outlet version  
Available option  
Control option  
Model

	<b>Output 1</b>	
<b>Torque (Nm)</b>	250	
<b>Int. ratio</b>	1,3	
<b>Number of axles</b>	2	

<b>Number of teeth</b>	22
<b>Module</b>	4,05
<b>Replace</b>	
<b>Replaced by</b>	

04/09/2006

### Command type

- |  |   |   |
|--|---|---|
| <input type="checkbox"/> Mechanical with lever remote control (TC) | <input type="checkbox"/> Hydraulic control      | <input type="checkbox"/> Pneumatic                  |
| <input type="checkbox"/> Ready for electric solenoid control       | <input type="checkbox"/> Depressure control     | <input type="checkbox"/> Constantly engaged         |
| <input type="checkbox"/> Mechanical with PUSH-PULL remote control  | <input type="checkbox"/> Electric control KES 5 | <input type="checkbox"/> Ready for detached control |

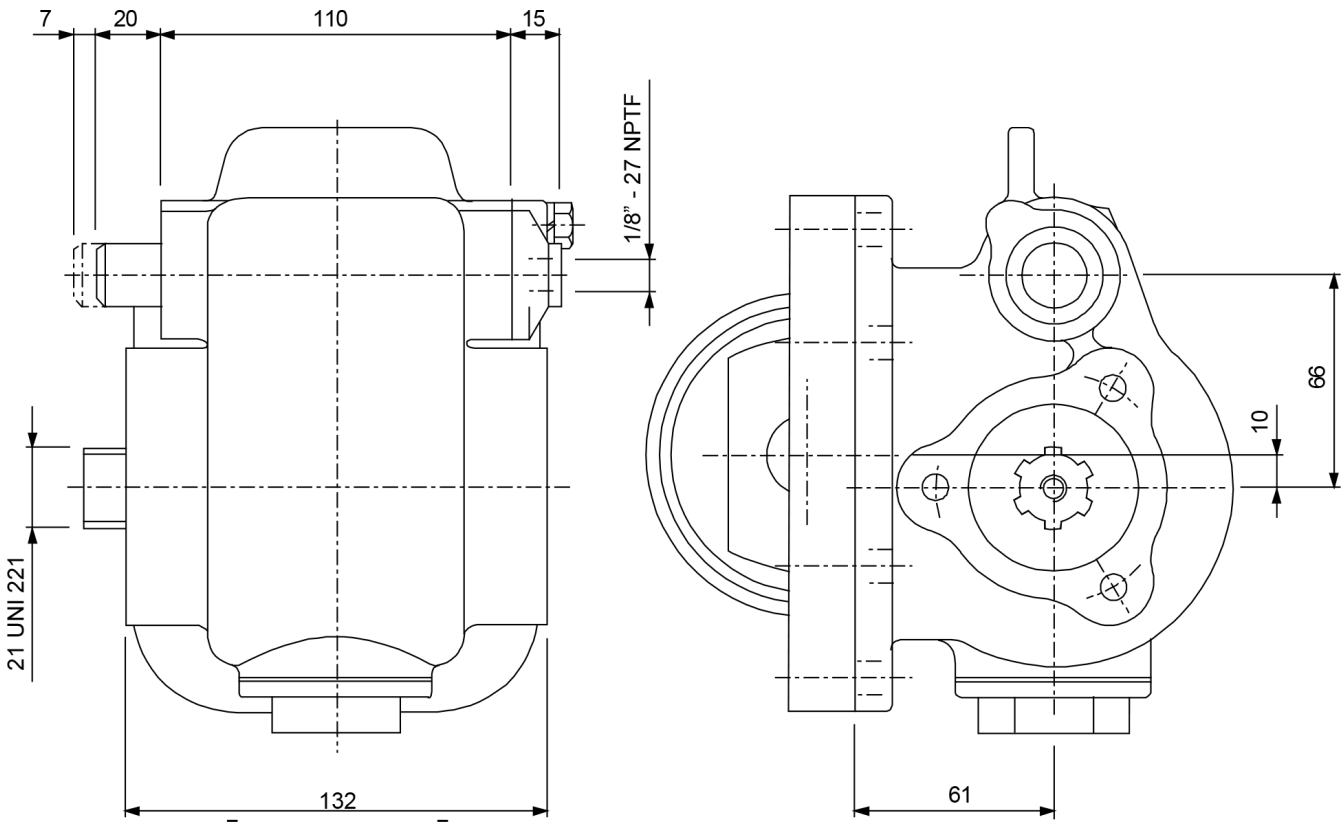

Interpump Hydraulics Spa a socio unico - **Business Unit PZB**

Sede Legale: via A. Mingozzi, 6 • 40012 Calderara di Reno BO - Italy

Sede Operativa: via A. Mingozzi, 6 • 40012 Calderara di Reno BO - Italy • T +39 051 6460511 • F +39 051 6460560 • info@pzbitaly.com • pzbitaly.com

Cap. Soc. Euro 2.631.600,00 i.v. • N. Mecc. BO 056383 • R.E.A. BO 444225 • C.F. 00883010241 • P.Iva IT02128140361

Soggetta ad attività di Direzione e Coordinamento da parte di Interpump Group Spa

