

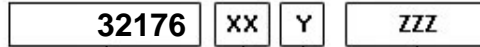

PZB®

D01P-0-03 - Pagina WebPTO PZB - rev. 0

32176

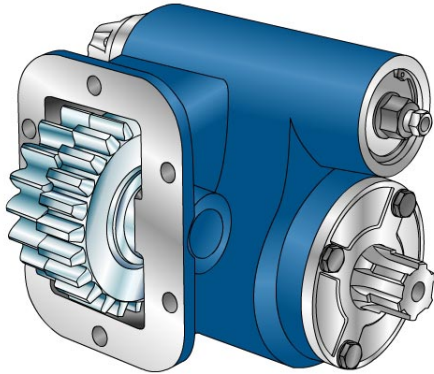

Outlet version
Available option
Control option
Model

	Output 1		Number of teeth	18
Torque (Nm)	400		Module	4,75
Int. ratio	1,67		Replace	
Number of axles	2		Replaced by	

10/10/2006

Command type

- | | | |
|--|---|---|
| <input type="checkbox"/> Mechanical with lever remote control (TC) | <input type="checkbox"/> Hydraulic control | <input type="checkbox"/> Pneumatic |
| <input type="checkbox"/> Ready for electric solenoid control | <input type="checkbox"/> Depressure control | <input type="checkbox"/> Constantly engaged |
| <input type="checkbox"/> Mechanical with PUSH-PULL remote control | <input type="checkbox"/> Electric control KES 5 | <input type="checkbox"/> Ready for detached control |

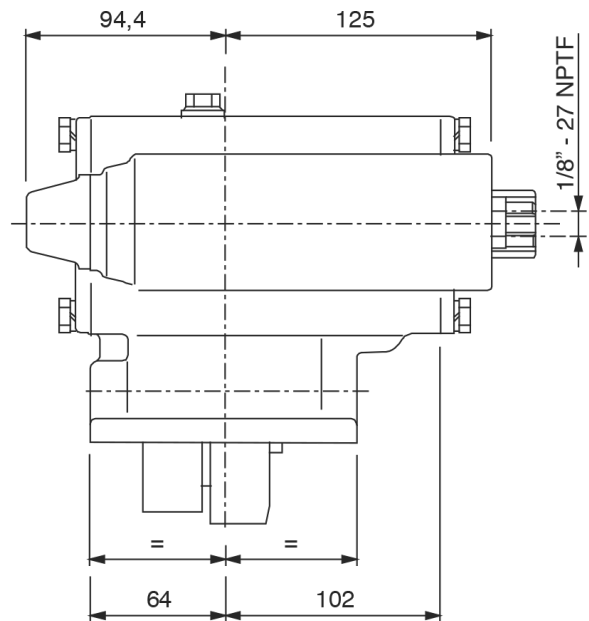
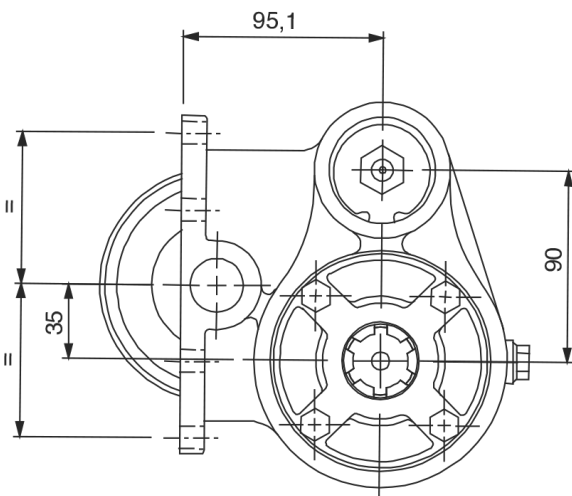

Interpump Hydraulics Spa a socio unico - **Business Unit PZB**

Sede Legale: via A. Mingozzi, 6 • 40012 Calderara di Reno BO - Italy

Sede Operativa: via A. Mingozzi, 6 • 40012 Calderara di Reno BO - Italy • T +39 051 6460511 • F +39 051 6460560 • info@pzbitaly.com • pzbitaly.com

Cap. Soc. Euro 2.631.600,00 i.v. • N. Mecc. BO 056383 • R.E.A. BO 444225 • C.F. 00883010241 • P.Iva IT02128140361

Soggetta ad attività di Direzione e Coordinamento da parte di Interpump Group Spa

