

Outlet version  
Available option  
Control option  
Model  
PTO

	<b>Output 1</b>		<b>Number of teeth</b>	43
<b>Torque (Nm)</b>	200		<b>Module</b>	2
<b>Int. ratio</b>	1,387		<b>Replace</b>	
<b>Number of axles</b>	2		<b>Replaced by</b>	

19/09/2017

### Command type

Electric     Hydraulic     Mechanical     Fixed engagement     Pneumatic     Vacuum system

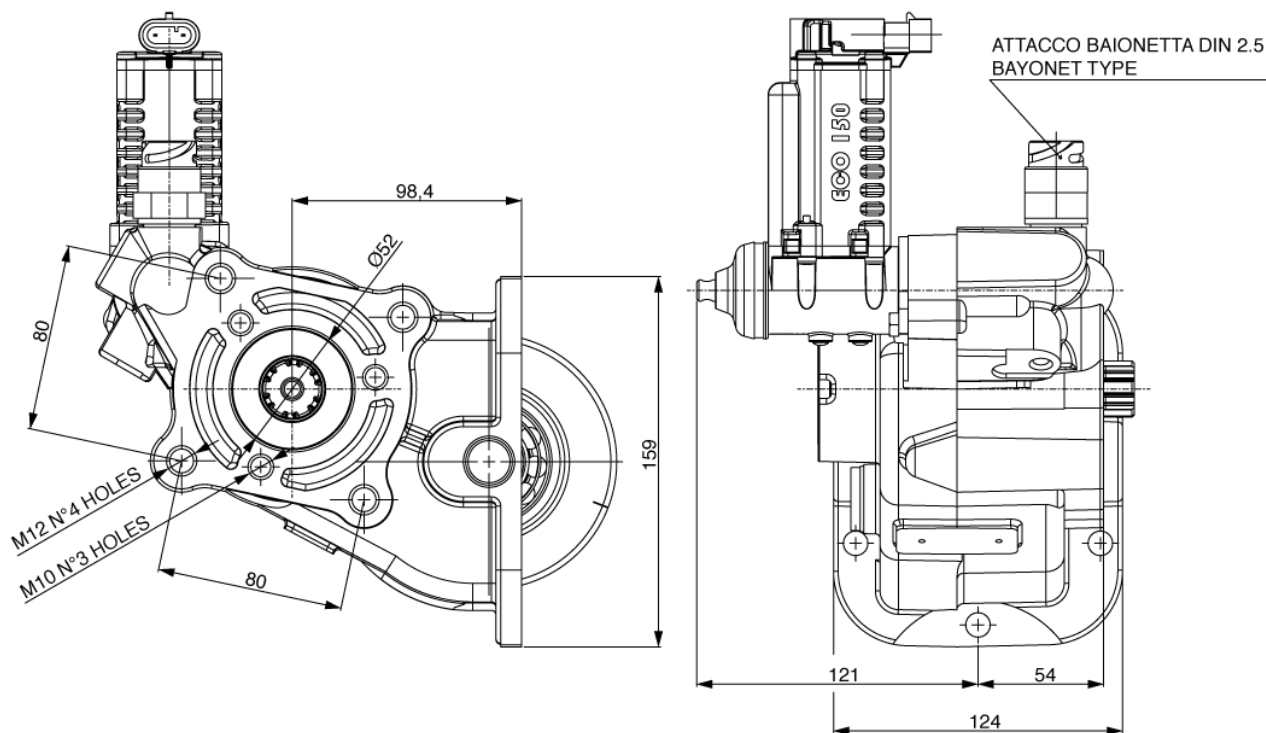

VEHICLE MOTION DIRECTION