

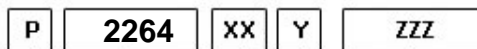

#PTO POS. M. D. EATON 4106-6109

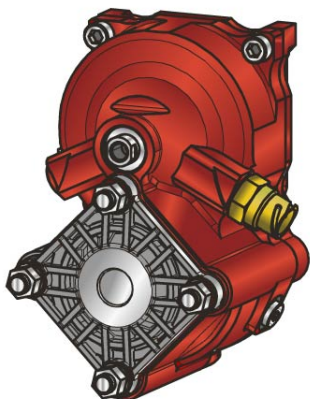

Outlet version
Available option
Control option
Model
PTO

	Output 1		Number of teeth	12
Torque (Nm)	300		Module	3
Int. ratio	1,945		Replace	
Number of axles	2		Replaced by	

Command type

Electric
 Hydraulic
 Mechanic
 Fixed engagement
 Pneumatic
 Vacuum system

