



PZB®

D01P-0-03 - Pagina WebPTO PZB - rev. 0



Shaft kit 205A6360000

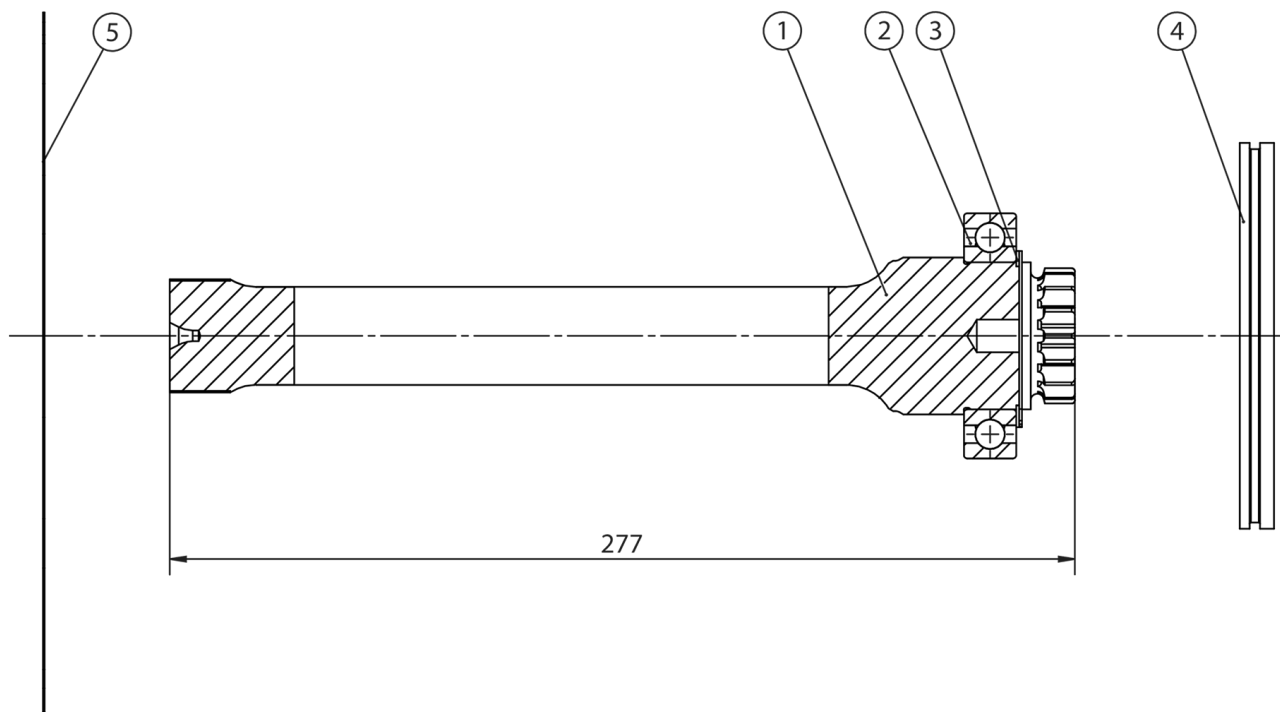

#Riferimento	Code	Description	#Quantita
1	11305540000	#ALBERO	1
2	01001016000	#CUSCINETTO 6009	1
3	00701004000	#ANELLO ELASTICO 45E	1
4	12702511000	#ANELLO RASAMENTO POMPA	1
5	09900403000	#GUARNIZIONE METALLICA	1
5	12901509000	#GUARNIZIONE IN FASIT SPESS. 0,5 MM	1

Interpump Hydraulics Spa a socio unico - **Business Unit PZB**

Sede Legale: via A. Mingozzi, 6 • 40012 Calderara di Reno BO - Italy

Sede Operativa: via A. Mingozzi, 6 • 40012 Calderara di Reno BO - Italy • T +39 051 6460511 • F +39 051 6460560 • info@pzbitaly.com • pzbitaly.com

Cap. Soc. Euro 2.631.600,00 i.v. • N. Mecc. BO 056383 • R.E.A. BO 444225 • C.F. 00883010241 • P.Iva IT02128140361

Soggetta ad attività di Direzione e Coordinamento da parte di Interpump Group Spa

